Travail de fin d'études: "Environmental impact assessment"

Auteur : Salikandi, Mohammad

Promoteur(s) : Richel, Aurore

Faculté : Gembloux Agro-Bio Tech (GxABT)

Diplôme : Master : bioingénieur en chimie et bioindustries, à finalité

Année académique : 2022-2023

URI/URL : <http://hdl.handle.net/2268.2/17737>

Avertissement à l'attention des usagers :

Tous les documents placés en accès ouvert sur le site le site MatheO sont protégés par le droit d'auteur. Conformément aux principes énoncés par la "Budapest Open Access Initiative"(BOAI, 2002), l'utilisateur du site peut lire, télécharger, copier, transmettre, imprimer, chercher ou faire un lien vers le texte intégral de ces documents, les disséquer pour les indexer, s'en servir de données pour un logiciel, ou s'en servir à toute autre fin légale (ou prévue par la réglementation relative au droit d'auteur). Toute utilisation du document à des fins commerciales est strictement interdite.

Par ailleurs, l'utilisateur s'engage à respecter les droits moraux de l'auteur, principalement le droit à l'intégrité de l'oeuvre et le droit de paternité et ce dans toute utilisation que l'utilisateur entreprend. Ainsi, à titre d'exemple, lorsqu'il reproduira un document par extrait ou dans son intégralité, l'utilisateur citera de manière complète les sources telles que mentionnées ci-dessus. Toute utilisation non explicitement autorisée ci-avant (telle que par exemple, la modification du document ou son résumé) nécessite l'autorisation préalable et expresse des auteurs ou de leurs ayants droit.



Master thesis report

submitted to obtain the degrees of

Master in Biology AgroSciences (BAS) of the University of Reims Champagne-Ardenne

Master in Integrative Biology and Physiology (BIP) of the University Paris-Saclay, operated by AgroParisTech

Master in Bioengineering: Chemistry and Bioindustries of the University of Liège

Consequential Life Cycle Assessment (CLCA) of Bio-Phenol Production

Presented by: Mohammad Salikandi

Defended the 19/06/2023

Supervised by Lorie Hamelin

at Toulouse Biotechnology Institute, INSA



from: 01 /02/2023 to 30 /06/2023

Bioceb supervisors:

S2 Supervisor: Benoit, Gabrielle, Paris-Saclay University

S3 Supervisor: Richel, Aurore; University of Liege - Gembloux Agro-Bio Tech

Confidentiality: Yes

Privacy expiration date: 01/12/2026

Contents

Thesis title	3
Acknowledgements	4
1. Introduction.....	5
1.1. Towards reaching the Paris agreement.....	5
1.2. Framework of this internship	6
2. Literature review	7
2.1. Foam for insulation in the construction sector	7
2.2. Phenolic resins : a key component of phenolic foams	8
2.3. Phenolic resin production- conventional method (fossil-based)	11
2.4. Bio-based phenolic resins.....	15
2.4.1 Lignin-based Phenolic Resins.....	15
2.4.1.1. Lignin Modification.....	16
2.4.1.2. Depolymerization of Lignin	18
2.4.2. Bio-oil based route	20
2.5.3. Research questions.....	20
3. Methodology	21
3.1. Life Cycle Assessment implementation.....	21
3.2. Biogenic Carbon Accounting	22
3.3 Heat and Electricity.....	23
3.4. Biomass Selection.....	24
3.5. Land use changes.....	26
3.6. Data Quality Requirements	26
3.7. Description of the scenarios.....	26
3.7.1. Baseline petrochemical scenario.....	27
3.7.2. Lignin scenario	28
3.7.3. Bio-based oil scenario.....	30
3.7.4. Relevant Alternatives not addressed for the lignin case.....	33
4. Results	35
4.1. Climate Change- Global Warming Impact	36
4.2. Eutrophication: Marine	37
4.4. Land Use	39
4.5. Water Use.....	40
5. Conclusion and discussion.....	43
6. Outlook.....	44
7. References.....	45

Thesis title

Consequential Life-Cycle Assessment (CLCA) of Bio-Based Phenol : comparison of different scenarios

Preface

I conducted this 5-month internship at Toulouse Biotechnology Institute (TBI) located in Toulouse, France. I worked on the LCA of the phenolic resin production processes and tried to compare different alternatives in the context of the EU-funded “Aligned” project under the Horizon Europe scheme. I consider this as a great chance for me to learn more about Life Cycle Assessment, and more specifically Consequential Life Cycle Assessment. During this time, I was supervised by Lorie Hamelin, who always kept a close eye on my learning route and progress along the project. It was under her supervision that I learned more details on consequential way of thinking and modelling, gathering information and conducting Life Cycle Inventories, to use tools like Activity Browser, and to interpret and analyse the LCA results and data. To contribute to Aligned project, I needed to participate in several team meetings and presentations with world experts of LCA field that helped me to learn more about LCA studies on the other sectors (like paper industry) and obtain new skills. Along the great supervision, I had the opportunity to communicate with Ph.D. students and postdocs of Dr. Hamelin’s group, which helped me significantly in comprehending many complicated concepts and improved my skills in the field. Moreover, we held weekly meetings supervised by Professor Hamelin to update the team members on our project improvements and challenges, and a productive discussion and question and answer to help each other through the projects, which was one of the most interesting and helpful part of this journey. Finally, I was given the chance to participate in Ph.D. defense of Ugo J., and Seunghye L, and several seminars and presentations, including from Dr. Davide Tonini (European Commission Officer at JRC Sevilla, Circular Economy Unit), and Dr. Paul West (Professor at University of Minnesota) on LCA-related topics, organized by Lorie Hamelin.

Acknowledgements

This report is the result of research and work done during 5 months at TBI, under the supervision of Lorie Hamelin from February till mid-June 2023.

I would like to take this chance to thank Dr. Lorie Hamelin, for her support during all the steps of this project. I have always wanted to learn more about LCA studies, and I think I was lucky enough to be accepted by her as an intern, and I believe here was one of the best possible places to create my LCA mindset as a junior researcher. Thank you for being super nice, calm, understanding, and super supportive to me. It was a real pleasure for me to work with you and it has always been a motivation for me to see how dedicated and active you are.

I also want to thank Carlos Robles, for his support and help during this project. More specifically, I would like to thank you for the help on data interpretation, understanding better the process involved in my first scenario, and finally on how to model this part properly. Without his help and input, this work would not have been completed.

During this incredible journey, I was part of a research team that included several Ph.D. and Postdoc students. What I truly liked about my time at TBI, was the fact that I felt the support of a team always with me, and I could readily use their experience and consultation for any challenges I faced. I want to thank Ugo, for always being there and answering my repetitive questions, helping me out with the project, and helping me to have a better understanding of Consequential LCA. I also want to express my gratitude to Christhel, and for her help on learning more about Activity Browser, and many more questions that I was asking her continuously. Last but not least, I want to thank Gleeza, for being there and supporting me during this project, and her advice on how to approach this project and her useful experience that she shared with me.

I would also like to take this opportunity to express my gratitude to the BIOCEB master's program. Many researchers, professors, and administrative people are involved in this amazing program, and I want to thank them all. More specifically, Professor Stephanie Baumberger, the main coordinator of this program, who always supported me during this journey. The secretary BIOCEB, Jeanne Beyrand, who helped me significantly during this period when I faced many challenges from VISA issues to accommodation. Furthermore, my supervisors from Paris Saclay, and University of Liege, Dr. Benoit Gabrielle and Dr. Auror Richel, for their support during my studies and my internship.

I have always been thankful for having my beloved ones. My lovely family and my girlfriend who always believed in me and provided me with all kinds of support during every single step of my life. Thanks for all the love and believe you had for me in any situation.

It's only with this huge support that I could manage to finish this work 😊

1. Introduction

1.1. Towards reaching the Paris agreement

The Paris Agreement calls for a “balance between anthropogenic emissions by sources and removals by sinks of greenhouse gases in the second half of this century (“Paris Agreement” 2015). Doing this involves three main pillars: (i) mitigation of current and future GHG emissions (emitting less for a given process, product, or service), (ii) inducing negative emissions, i.e., biophysical removals of GHG from the atmosphere to elsewhere (“SPECIAL REPORT-Global Warming of 1.5 °C” n.d.) and (iii) keeping fossil carbon in the ground, which involve substituting fossil carbon by other alternatives such as biomass or C obtained through direct air capture.

Bioeconomy, a vision that is being put forward in Europe since at least the release of the first bioeconomy strategy in 2012 (European Commission 2013), is tackling the last pillar by promoting the use of renewable biological resources to provide service or produce goods, providing society with a more circular and sustainable economy.

In this context, one service that is gaining increasing attention is the supply of bio-based materials, made either fully or partly of renewable biological resources. The idea of using bio-based materials is gaining more and more attention since they are biodegradable, renewable, and could be produced through sustainable methods (McCormick and Kautto 2013). Bio-based materials utilization offers a range of benefits that are not limited only to the environment, but they also include the social and economic aspects. Some of these advantages are improved waste management, more job creation, increased economic growth, and reduction in GHG emissions and environmental impacts (Barañano et al. 2021).

However, increasing the supply of bio-based materials (and chemicals) imply tapping into the potential of a large diversity of renewable biological resources, that may not be without consequences on the environment if not properly planned. For many materials, it is unclear whether bio-based options really yield environmental improvements (beyond climate change) in comparison to their fossil counterpart.

In the context of bioeconomy, and to address the environmental challenges associated with the use of fossil-based materials, this work focused on alternative bio-based routes to replace the fossil-based phenol used in phenol-formaldehyde resins within the construction section, or more specifically, for phenolic foams used as insulation materials for walls. Despite bio-based phenolic foams are the targeted final product, the scope of this work is on the bio-based phenol only.

1.2. Framework of this internship

This internship/master's thesis is defined in the context of an EU-funded project called "Aligning Life Cycle Assessment Methods and bio-based sectors for improved environmental performance" (ALIGNED). The project will provide a modelling structure to analyze the socio-economic and environmental aspects of bio-based industries. To do so, research centers and industrial partners are collaborating and focusing on five bio-based sectors which are: pulp and paper industry, construction, textile, woodworking, and bio-chemicals. 12 industrial and academic partners are involved in this project from several European countries and the work is divided into 8 work packages (WP).

The emphasis of current work is on WP2 which tries to improve bio-based industry in the construction sector. The main goal of WP2 is to improve the validity of LCA methodologies by applying them to a real-life example. The selected case here is on thermal insulation materials, and more specifically phenolic foams used for wall insulation. These foams are essentially made out of phenolic resin (and additives), as further detailed in section 2.2. This phenolic resin, in turns, consists of ca. 65% phenol, and 35% formaldehyde.

Kingspan, the company involved in WP2, produces phenolic foams (for wall insulation) called "Kooltherm", and they are interested in purchasing phenolic resin where the phenol portion is bio-based.

By conducting CLCA, several alternative routes are here studied and compared to improve the environmental performance of bio-based phenol production.

The alternative routes are selected after consulting with the industrial partners and based on their needs and current stance. As already agreed in the Aligned project, the company assists academic partners with the supporting information and approaching the projects, and finally, they will act and make investment based on the results obtained from this work.

2. Literature review

2.1. Foam for insulation in the construction sector

The construction sector is among the biggest industries in the world. It provides the society with the needed infrastructure and buildings and includes a huge range of economic activities (“The European Construction Sector - A Global Partner” 2016). To satisfy the need for more buildings, this industry utilizes resources and generates a notable amount of waste. The construction sector consumes almost 40% of raw materials and it is responsible for the production of approximately 55% of the GHG emissions in the world (Federica Pozzi 2022).

Nowadays, the new regulations and increasing public awareness towards energy efficiency in the construction sector, highlighted the importance and growth of the insulation market. Bio-based insulation market has increased 40% during the past 3 years and it has 10% of market share in 2022 (Lecompte 2022). These numbers clearly demonstrate the increasing interests and opportunities associated with insulation materials. To satisfy this demand, foams are widely utilized for insulation purposes (Aseeva 2004).

In general terms, foams are produced by introducing bubbles into a matrix. Different types of foam can be produced based on the nature of matrix, bubbles, and the methods used for putting bubbles in the matrix. In an industrial scale, a gas stream needs to go through an orifice and produce bubbles in the solution. The growth and separation of bubbles are affected by several parameters like

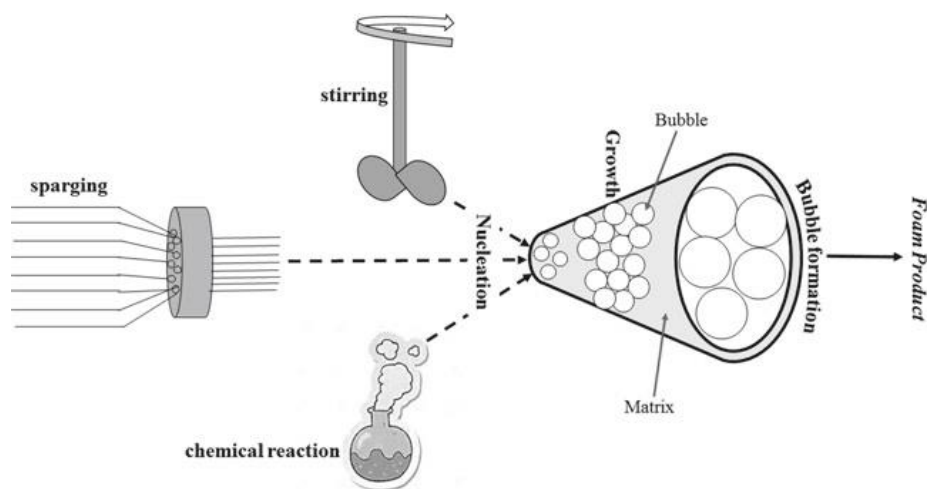

Figure 1. Fossil-based production of insulation foam. (Taken from Dickinson 1992)



gas flow rate and interfacial tension. The process is shown in Figure 1 -taken from (Dickinson 1992), which depicts the details of foam production (Dickinson 1992).

Polymeric foams consist of a gaseous phase which is dispersed in the solid polymer matrix (Sandhya, Sreekala, and Thomas 2022). Gas diffusion in the solid phase is a critical step since it impacts the structural parameters and characteristics of the final foam (Zuluaga et al. 2018). Moreover, the materials used for foam processing can affect the foam final applications, and polymers are often used for this purpose due to their valuable properties (Sandhya, Sreekala, and Thomas 2022). A polymer with low density could be used to produce lighter foams; and a polymeric foam with low heat transfer properties could be a good potential as insulation materials (Ashida 2006).

Polystyrene, polyurethane, polyvinyl chloride, and phenol can be used as main component to produce foams. In comparison with phenolic foams, the previously mentioned foams proved to be less brittle and friable. On the other hand, toxic gases are generated during the production process of these foams, and they show less fire resistance compared to phenolic foams (H. Li et al. 2022).

2.2. Phenolic resins : a key component of phenolic foams

Various methods are used to produce phenolic foams (PF) and curing of the phenolic resin and increase of blowing agent form the foams in these methods. The two key factors in phenolic foam production are the viscosity and reactivity of the phenolic resins (or more precisely phenol-formaldehyde resins, but herein referred to as phenolic resin for simplicity, despite being a mix of both phenol and formaldehyde) (Mougel et al. 2019). Other parameters affecting foam quality and properties are water content of the resin, pH, and monomer quantity. In this process, emulsifiers and surfactants are of great importance since they adjust the properties of phenolic foams. One of the most used surfactants in previous studies is Tween 80 (polyethylene glycol sorbitan monooleate)(H. Li et al. 2022).

The various processes suggested for the Phenolic Foams production are batch, semi-continuous, continuous, and microwave foaming process. From an industrial point of view, batch process is the easiest and cheapest option (H. Li et al. 2022). In the batch process, emulsifier, resin, and additives are added and mixed, and then, blowing agent and catalyst are added. Next, the foam



mixture is heated and moved to the mold, and after end of the curing step, further drying takes place (Pilato 2010b).

Phenolic Foams has other advantages such as low smoke density and low cost (Sandhya, Sreekala, and Thomas 2022). Furthermore, PFs proved to have a low thermal conductivity, high resistance to solvents and chemicals, and they are stable in a wide temperature range (Song, Chung, and Kim 2014). It is important to note that the principal raw material used to produce phenolic foam is phenolic resin and it makes 50-90 % of the foam (Xiao, Huang, and Ding 2017). Phenolic resins could also be used in the production of fiberboard, plywood, and other wood-based panels. One of the most used resins is obtained from phenol and formaldehyde that has several applications. Phenol formaldehyde resin has interesting properties like dimensional stability, electrical insulation, and high chemical resistance (El Mansouri, Yuan, and Huang 2018). From here onwards, the term “phenolic resin” will be used to refer to phenol-formaldehyde resin specifically. Due to these several interesting properties that phenolic resin offers, its global market size has increased notably, and in Figure 2 (foams), more information on the global market and producers are presented (“Forecast of Global Phenolic Foam Board Market 2023” 2019).



Figure 2. Global market of phenolic foams. (Taken from “Forecast of Global Phenolic Foam Board Market 2023” 2019)

Main properties of phenolic foams such as flame retardancy, air tightness, and compression strength depend on the base phenolic resin. Several different parameters like reaction temperature, pH, formaldehyde/phenol molar ratio, reaction time, and catalysts type affect the phenolic resin properties (Hu, Zhao, and Cheng 2015).

Phenolic resins are categorized into two major groups: Novolac (thermoplastic phenolic resins) and Resole (Thermoset phenolic resins). The latter is the one investigated in this work. The production condition and characteristics for these two categories are different. When the phenol/formaldehyde ratio is less than one and an alkaline catalyst is used, resoles are produced. On the other hand, novolac can be made when the phenol/formaldehyde ratio is more than 1, while an acid catalyst is used (Hattali et al. 2005). Both types of these resins are foamable, and they can be potentially used as the raw material for phenolic foam preparation. At the room temperature, novolacs are solid and not easy to handle for the process, and thus, liquid resoles are preferred for the foam manufacture (Aseeva 2004). Figure 3 shows the synthesis pathway and operating conditions for resole and novolac production (Pilato 2010a).

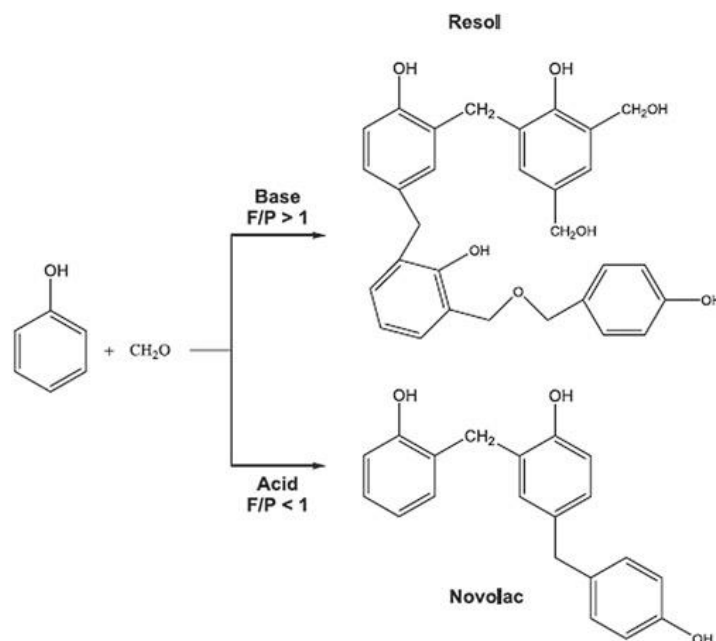

Figure 3. Synthesis conditions for producing resole and novolac resins.
Taken from (Pilato 2010a)



2.3. Phenolic resin production- conventional method (fossil-based)

Phenolic resins were discovered in 1909 by Leo Bakeeland as they are the first synthetic resin to develop. They are hugely demanded in plywood production for construction sector, and in wood applications (Siddiqui et al. 2017). Normally, they can be found in different forms, and they possess various characteristics based on the intended application.

More than 95% of the phenol used for resin production is petrol-based and comes from benzene and cumene production pathways. According to the world petrochemical report in 2013, more than 40% of petrol-based phenol in the market was used for phenolic formaldehyde resin production in United States (SRI Consulting 2010).

Phenolic resin production includes three steps in sequence; starting from addition of formaldehyde to phenol, and followed by condensation reaction, and then, polymeric resin curing according to their final application (Siddiqui et al. 2017). The final phenolic resin is normally dark reddish and the operating condition for different processes can be very different. For example, the synthesis could take place in a wide range of temperature, starting from almost 25 °C and going up to 135 °C (Eckelman 1999).

Initially, the addition of formaldehyde to phenol takes place in presence of a catalyst at low temperatures like 60 °C and a pH of 8 to 13. After addition of formaldehyde to the phenol, ortho- or para-monosubstituted methylol phenol will be formed. If formaldehyde is freely available in excess, di-methylol or tri-methylol phenols can also be formed. Figure 4 shows the different possible pathways in more detail (Tonge and Eng 2007).

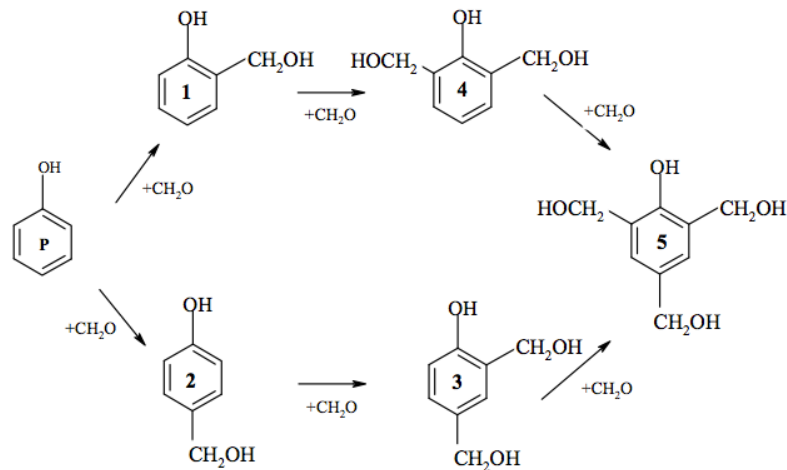

Figure 4. Reaction pathways for addition reactions of PF resoles- taken from (Tonge and Eng 2007)

During the condensation reaction, methylol phenols react with unsubstituted phenols or other methylol phenols and they form phenolic resin intermediates and produce water or leave unreacted phenol and formaldehydes as side-products (Siddiqui 2013). In this step, there is an increase in the molecular weight of polymer, which enhances viscosity and solid content of the polymer. It is of great importance to identify the determining parameters in this process and to know how to manipulate them to obtain the desired characteristics of the final resin.

Formaldehyde/phenol molar ratio is one of the important factors that can directly affect the molecular weight of resins. An increase in F/P molar ratio will result in a more rigid resin structure, higher resin viscosity, and lower gel time. On the other hand, in the high F/P ratios, there are health risks associated with free formaldehyde content that needs to be considered (Siddiqui et al. 2017).

The second key parameter is curing temperature which can change the properties of final resins. While lower curing temperatures are preferred from an energy consumption point of view, unstable ether bridges are formed at less than 170 °C, and they try to reach a more stable arrangement at temperatures higher than 170 °C (Wang, Leitch, and Xu 2009).

Another notable factor is the catalyst type and quantity used for the reaction. The final resin will have lower gel time and higher molecular weight if an alkaline catalyst is used. On the other hand,



increasing catalyst content up to 10% wt., enhances the adhesive strength of resin. On the other hand, adhesive strength decreases in response to an increase of the catalyst content more than 10% wt (Abdelwahab and Nassar 2011).

Figure 5 shows a sample for an industrial-scale production of phenolic resins. In a conventional plant, fossil-based phenol and formaldehyde are charged into a reactor, which is the main part of the process. The reactor needs to include an agitator and should be equipped with heating jackets to allow temperature control, as proper mixing and temperature control are key parameters in the process. After the completion of reaction, washing and decanting is normally done to obtain final product with higher quality. More details are provided in the Process Flow Diagram of a conventional plant in Figure 5 (Gardziella, et, al., 2013).

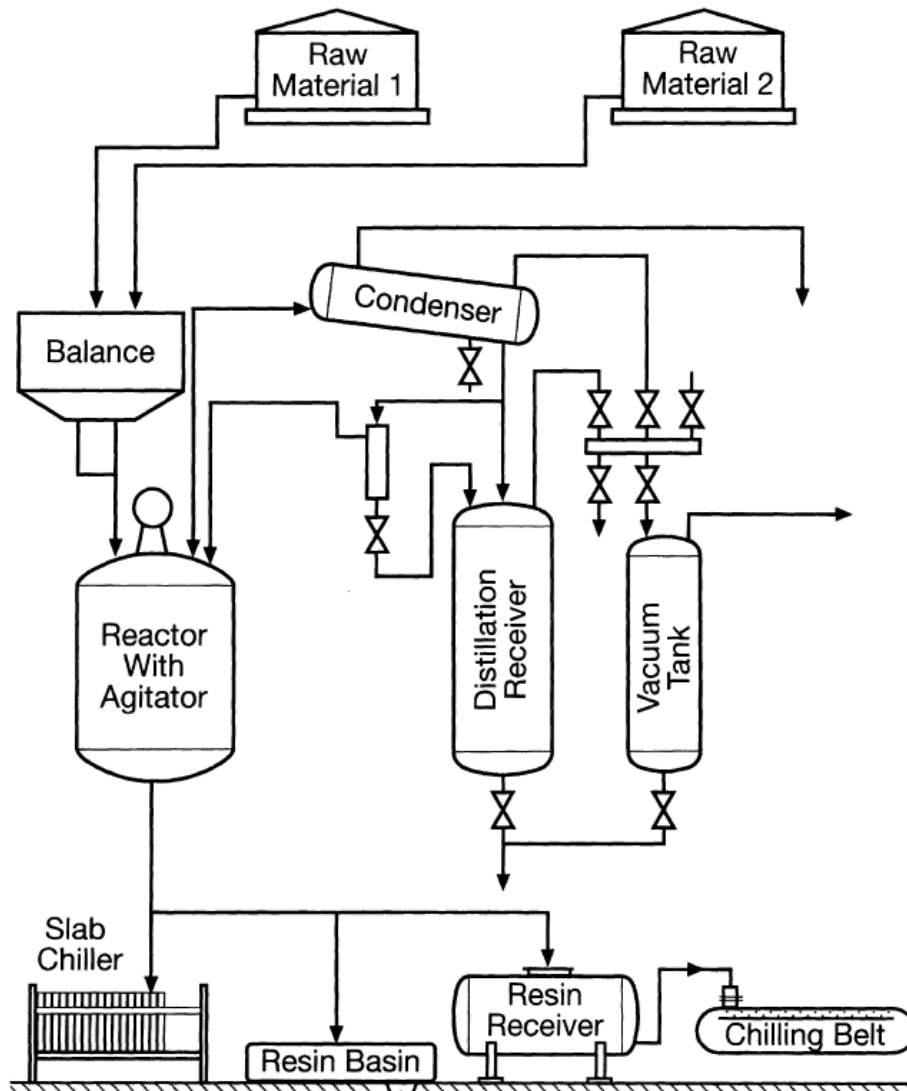

Figure 5. Flow diagram of a resin production line- taken from (Gardziella, et. al., 2013)

Apart from all the advantages, there are two significant challenges associated with PFs that need to be discussed. Phenol is a petrol-based chemical and the current need for sustainable raw materials made researchers to look for alternatives that have similar or better performances (El Mansouri, Yuan, and Huang 2018). Additionally, PFs own mechanical weaknesses and they are friable and brittle due to the high rigidity. A significant number of methylene bridges are found in the pure



phenolic foams, which limits their construction applications and makes them very brittle (Sandhya et al., 2022).

As a solution to the abovementioned challenges, researchers tried utilizing biomass to modify the molecular structure of phenolic foams. A renewable biomass source for phenolic resins that also works as a toughening agent could address both problems simultaneously. To replace phenol with lignin in the synthesis route was suggested as a sustainable solution for the abovementioned problems (Z. Gao et al. 2021).

2.4. Bio-based phenolic resins

2.4.1 Lignin-based Phenolic Resins

Lignin has the potential to be used as a bio-based phenolic source and replace petrol-based phenol in the production of phenolic foams. The challenge is its lower reactivity compared to petrol-based phenol since its reactive sites are less available for the reaction with formaldehyde (C. Gao et al. 2021).

Lignin is the most abundant aromatic polymer in the world, and it forms 15-40% w/w of the dry mass of plants (Doherty, Mousavioun, and Fellows 2011). Due to its very specific properties and structure, several innovative applications could be considered for lignin to convert it to value-added materials (Banu et al. 2019). It has a very complex structure and high molecular weight which could significantly vary based on the biomass source and extraction method (Z. Gao et al. 2021). At this moment, although around 300 billion tons of lignin is produced annually at the global scale (Siddiqui et al. 2017), almost 98% of it is burned for energy production purposes in paper and pulp industry (Zuluaga et al. 2018).

Conventionally, most processes focus on removing lignin from cellulose and hemicellulose, and then, to use cellulose for pulp and paper industries, biofuel production, or other valorization methods (Sun et al. 2018). The common routes for the separation of lignin from lignocellulosic biomass are organosolv, kraft lignin, hydrolysis lignin, and liginosulfonate. In most of these methods, the structure of lignin changes notably and the final version of lignin is unreactive and very condensed (Van den Bosch et al. 2017). This is the reason that modification or depolymerization are suggested to increase lignin reactivity for resin production or other applications (Korányi et al. 2020).

Lignin owes several interesting characteristics such as antimicrobial effect, adhesion, high thermal stability, and biodegradability (Z. Gao et al. 2021). Moreover, it has several active functional groups like phenolic hydroxyl, and alcoholic hydroxyl, which make it an interesting alternative for phenol (Azadi et al. 2013). To replace phenol with lignin in this process, two main routes are proposed:

1. Direct use of lignin without any modifications.
2. Chemical modification/ depolymerization of lignin prior to its use (Zuluaga et al. 2018).

The first option does not require any extra process and chemicals, while applying lignin in this way would reduce phenol properties and it is not desired (Z. Gao et al. 2021). Although the second option needs extra process and chemicals; modifying lignin will increase the activity of copolymerization of lignin with formaldehyde and phenol by enhancing the phenolic hydroxyl group content. Moreover, Lignin has phenolic groups which can be depolymerized and used for phenolic resins production (Z. Gao et al. 2021). The following part explains more on lignin modification and depolymerization methods and provides more details on several possibilities for each of the routes.

2.4.1.1. Lignin Modification

Modification methods are used to enhance the efficiency of copolymerization since the molecular weight of lignin is relatively high and it has a complex structure. Common methods for lignin modification are demethylation, hydroxymethylation, and phenolization (Z. Gao et al. 2021).

i) Phenolic Modification (phenolization).

This reaction can be done with an acidic or basic catalyst and helps to reduce the molecular weight of lignin. As shown in Figure 6 (Z. Gao et al. 2021), initially, the ether bond is broken and then, it can react at para or ortho position with phenol and produce two different structures (Siddiqui et al. 2017).

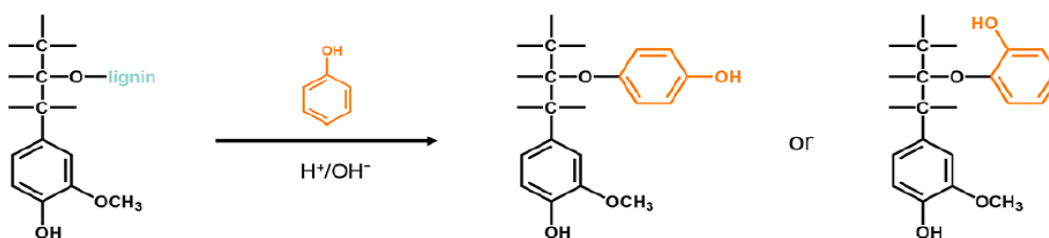

Figure 6. Phenolization of lignin. Image integrally retrieved from (Z. Gao et al. 2021)

ii) Demythylation Modification.

In this reaction, nucleophiles like HS^- or SO_3^{2-} attack lignin under high pressure and temperatures. As depicted in Figure 7, the methoxy group seated on the active position of lignin is converted to a phenolic hydroxy group.

This method could be efficiently utilized to increase the active sites of lignin, but the reaction condition is extreme, and this is the main reason that this method has not been fully industrialized yet (Z. Gao et al. 2021).

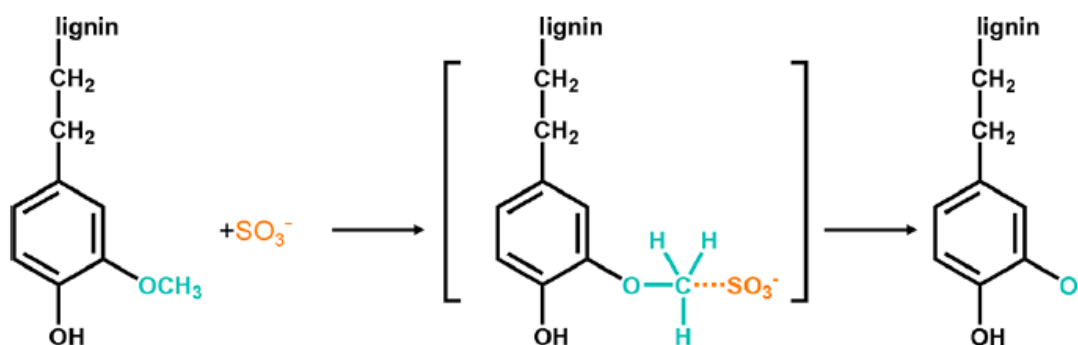

Figure 7. Demythylation modification of lignin. Image integrally retrieved from (Z. Gao et al. 2021).

iii) Hydroxymethylation Modification.

This reaction tries to enhance lignin activity by adding a hydroxymethyl group to the aromatic ring of lignin (Figure 8) (T. Li et al. 2018). This method could increase the activity of lignin in very small scales, while it can be significantly useful if used in combination with other methods like phenolization (Z. Gao et al. 2021).

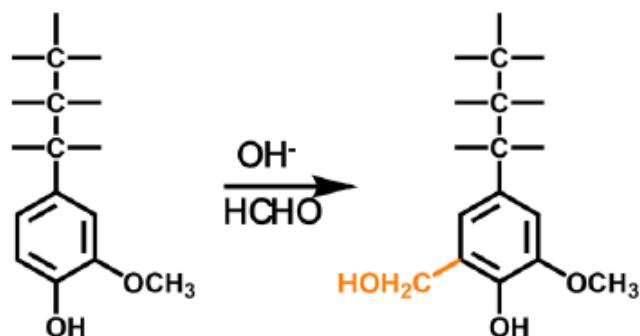

Figure 8. Hydroxymethylation modification of lignin. Image integrally retrieved from (T. Li et al. 2018)



2.4.1.2. Depolymerization of Lignin

Lignin is a polyphenolic polymer, and thus, to use it effectively to produce phenolic resins, it could be depolymerized through several pathways into monophenols. A brief explanation of different possibilities is provided here.

Hydrolysis. In this method, lignin is depolymerized in a medium where water is used as solvent. To increase the efficiency of this method, heating, using catalysts, or pressurizing are suggested. Compared to the other common routes, hydrolysis has lower energy consumption (Siddiqui et al. 2017).

Metal-catalyzed depolymerization. Bio-oil containing notable amount of phenolic compound can be produced through metal-catalyzed depolymerization, and this could be later used to produce lignin-based phenolic resins (Kloekhorst and Heeres 2015).

Oxidative Depolymerization. As an effective method for lignin depolymerization, it includes alkali catalytic oxidation, electrocatalytic oxidation, organometallic catalytic oxidation, and nonmetallic organic catalytic oxidation.

In comparison with petrol-based phenolic resins, lignin-based phenolic resins offer several advantages that could not be easily neglected. For example, lignin-based phenolic resins are produced at a much lower cost and at the same time, they have better mechanical and thermal properties. Furthermore, toxic residue content is less for lignin-based phenolic resins compared to the petrol-based case (Z. Gao et al. 2021).

In different works, researchers tried to use different options for lignin modification and depolymerization and prepare the resin for various applications. In each of these studies, petrol-based phenol was substituted with different ratio of lignin, and the lignin was extracted from different biomass sources. Supplementary Information (SI) **Table 1.** summarizes the information extracted from almost 60 works done previously in this field, to provide an overview of the possibilities and various options that were already tested. This table provides specific details on the lignin source, lignin extraction method, and further details such as molecular weight of extracted lignin. Then, it shows if the lignin was directly incorporated into the process, or if the modification and depolymerization was done to improve the quality and performance of extracted lignin. In this part, specific modification and



depolymerization methods, and the chemical used are also explained. Each of these lignin categories were prepared for different final applications that are mentioned in the table. The last column expresses the substitution rate of petrol-based materials with the lignin-based phenolic compounds.

2.4.1.2.1 Lignin-first methods

Often, the industry view is to use residual lignin, for instance stemming from the Kraft process in pulp and paper production. However, in the perspective of launching a wide and serious strategy based on lignin for the bio-based construction sector, it has to be anticipated that quickly, residual lignin will be used up and alternatives sources, i.e., those that can react to a demand change, will be needed.

Recently, a new concept called lignin-first has been introduced for lignin supply to the bio-based industry. One of the most common and studied lignin-first methods currently is Reductive Catalytic Fractionation (RCF) (Renders et al. 2017). Other options include AAF and Organosolv that will be further detailed in the next section.

In these methods, lignin is extracted using a solvent of choice, and then, simultaneous fractionation of biomass and catalytic conversion of lignin take place. Final products will be a lignin oil phase which is rich in phenolic oligomer, dimer, and monomer; and a cellulosic pulp that can be valorized in several ways. Several possibilities have been tested for this process, and different solvents, catalysts, reaction conditions and raw materials were studied (Schutyser et al. 2018). In the following section (methodology), more details on recent works in the RCF field are presented, and their choices and final yields are summarized.

For lignin-first approaches, crops are specifically cultivated to produce and utilize lignin and thus, crop cultivation and all the agricultural efforts, direct and indirect land use changes, water consumption, and fertilizer are consequences of growing the biomass for this purpose.

Next step is biomass size reduction to prepare and crush the biomass for the main reaction and process. From this stage, some dust is obtained that could be valorized and burned to produce heat and electricity and avoid marginal heat and electricity production. The main part is to separate lignin from other compositions and there are already several methods to do so. Regardless of the



method used in this stage, the lignin is then further purified and then used as a replacement for fossil-based phenol (Korányi et al. 2020).

It is important to note that there are several ways to separate/isolate the lignin from biomass. 3 main methods have been identified for separating lignin as lignin-first routes are RCF, AAF, and organosolv. For each of these methods, the process flow, chemicals needed, energy demand, operating conditions, and by-products are different and thus, they can create different impacts on the environment. More details for each process are shown separately in the following sections.

2.4.2. Bio-oil based route

Another option to produce bio-phenol is to use bio-oil as raw material. In these routes, bio-oil is obtained from biomass, and then there are several possibilities and pathways to convert the bio-oil to bio-phenol. More specific details on the process flow, different possibilities, and justification of the selected option are explained in the next part.

2.5.3. Research questions

The current study focuses on the identification of possible routes for phenol production and to replace petrochemical phenol. The next step is to evaluate the environmental impacts associated with each suggested scenario to find the best possibilities. Thus, the main research question in this study is defined as:

“What is the best route for production of bio-phenol from an environmental point of view to replace the petrol-based phenol?”

This question has a few implications: (i) that a particular bioeconomy conversion pathway is considered (two are considered in this report; this is the object of research objective 1 as further detailed), (ii) that there is a temporal scope considered (only long-term is studied here), and (iii) that there is a geographical scope (as further detailed, the production is considered to take place in the Netherlands, based on Kingspan’s envisioned investments).

This research question involves the need to uncover the different possibilities for bio-based phenol production, as formulated in Research Objective (RO) 1:



RO1. What are the different possibilities for bio-based phenol production, and what are the processes involved and operating conditions of these routes?

3. Methodology

3.1. Life Cycle Assessment implementation

Consequential modelling method was used based on the ISO 14040/44 (“ISO 14040:2006, Environmental Management — Life Cycle Assessment — Principles and Framework” 2006) to study the environmental impacts of bio-phenol production. The key goal of this work was to assess the consequences of phenol production through lignin-based and bio-oil routes, and to provide a comparison of different scenarios including a comparison to the conventional methods. To achieve this, system boundary expansion was done and the whole value chain was included. Induced or avoided impacts of the selected processes and materials are studied in the Consequential LCA method (Brandão M, et. al., 2022). Thus, in the current work, valorisation for all the by-products are included as well as heat and electricity productions in the process that results in the avoided marginal heat/electricity production.

The consequential Ecoinvent V3.9.1. (“Ecoinvent v3.9.1”, 2022) was used as the source of background LCI data. All the selected options from ecoinvent database for different streams are specified in the table 2 provided in SI. Foreground data is obtained from the literature and own estimation and calculation, which is further detailed in the SI 2. Marginal suppliers who react to the demand change were considered for this study. The Netherlands is considered as the geographical scope, i.e., where the production will take place, on the basis of Kingspan’s investment plans. The location mostly affects the electricity mixes, while most of the biomasses and chemicals used in the project are sourced internationally (in Europe or globally).

The functional unit is defined as “**1 kg of avoided petrol-based phenol**”, and this functional unit is defined similarly for all the suggested routes so that their impacts could be compared to each other. The open-access software Brightway 2.0 (through Activity Browser interface) was used and environmental footprint (EF) V3.1 Life Cycle Impact Assessment (LCIA) methodology was selected



to analyse and compare the environmental impacts of each route. (European Commission 2021). All environmental impacts were calculated, but only six are presented herein with detailed interpretation: Global Warming, freshwater eutrophication, marine eutrophication, land use, water use, and particulate matter. These 3 first ones were judged relevant at the light of the climate crisis and the exceeded planetary boundaries (Steffen et al. 2015), respectively, while respiratory inorganics, water and land were considered to be of particular relevance of the present case study.

The goal of this work is to compare the new options for (bio)phenol production, which will be used in the production of insulation materials. Yet, the scope is only for the bio-based phenol production, its use for phenolic foam production and use is to be investigated in later stages within the ALIGNED Project.

In the inventory analysis step, effort was made to understand the processes, energy, and material streams needed for the investigated alternatives. In this context, information on the required facilities and utilities, materials, and produced emissions are studied considering the functional unit.

Consequential modelling was used in this study since it aims to analyse the impact of novel processes, so this is mostly a future-based study. To reach this goal, marginal suppliers and markets was directly used from Ecoinvent consequential database.

3.2. Biogenic Carbon Accounting

There are two types of carbon dioxide emissions distinguished for the foreground inventories: biogenic emissions that come from biomass and its transformation, and fossil emissions which comes from fossil hydrocarbons. CO₂ emissions from biogenic category are considered as a part of the “short cycle”. This means the exchanges between the atmosphere and C pools only occurs within several months or decades. Therefore, this category is considered as stable and to compensate for each other and referred as “neutral” Carbon. This accounting method is used in the EF methodology and in this work. This implies a characterization factor of 0 kg CO₂e per kg CO₂ biogenic for both flows uptaken from the atmosphere, and those released to the atmosphere. However, any induced sequestration (e.g. through biochar) involve a characterization factor of -1 kg CO₂e per kg CO₂ sequestered with this



method.

On the other hand, CO₂ emissions stemming from fossil fuels are considered as “long Cycle”, since they require millions of years to be compensated for or reach an equilibrium.

3.3 Heat and Electricity

Given the importance of heat and electricity in LCA, this section describes the marginal heat and electricity processes considered in this study.

There are two categories of heat that are distinguished as low temperature (for <100 C) and high temperature (>100 C) heat. In fact, based on the process condition, the required or produced heat could be low or high temperature. For low temperature (LT) heat, the production through heat pump was considered (Heat, air-water heat pump 10kW was selected from the Ecoinvent database). For high temperature (HT) heat, electrified heat was considered from Ecoinvent.

The marginal electricity for the Netherlands, on the other hand, was directly taken from the consequential Ecoinvent database, which it turns is based on predictions from the European Commission (European Commission 2020). Table 1 describes the different process involved for the high voltage electricity and it includes the contribution of each for production of 1 kWh of high voltage electricity in the Netherlands. As it can be seen, it is essentially based on wind (ca 58%), wood (ca. 27%) and natural gas (ca. 14%), and minor portion of nuclear (>1%).

Table 1. Description and composition of activities involved for 1 kWh of high voltage electricity in the Netherlands (plant location).

Amount	Unit	Product	Activity	Location
0.14033	kW.h	Electricity, high voltage	Electricity production, natural gas, combined cycle power plant	NL
0.0040311		Electricity, high voltage	Electricity production, nuclear, pressure water reactor	NL

	European Master in Biological and Chemical Engineering for a Sustainable Bioeconomy			 
	 		 	

0.26708		Electricity, high voltage	Electricity production, wood, future	GLO
0.30605		Electricity, high voltage	Electricity production, wind, 1-3 MW turbine, offshore	NL
0.0169		Electricity, high voltage	Marginal high voltage electricity	NL
0.28251		Electricity, high voltage	Electricity production, wind, >3MW turbine, onshore	NL
3.02525e-09	kilometre	Transmission network, electricity, high voltage direct current aerial line	Market for transmission network, electricity, high voltage direct current aerial line	GLO

3.4. Biomass Selection

An important step in this work is the biomass selection for the bio-phenol production process. Different biomasses have different chemical and biochemical compositions, which result in different operating conditions for each. Moreover, the cultivation and agricultural practices for each are different and needs to be considered. To find suitable biomasses, information from SI-Table1, and works done by Tscholkow et. al., and Bartling et. al., were used and thus, birch, willow, and poplar were selected as they previously proved to be promising for RCF reactions (Tschulkow et al. 2020)(Bartling et al. 2021).

Data from phyllis2 platform (Phyllis2, 2022) is used to have an estimation of the chemical and biochemical composition, and moisture content of the selected biomasses. For each of these options, 5 different sample were selected from database, and the average was calculated. Table2 summarizes the chemical and biochemical composition of selected biomasses, and it also present the selected item in Ecoinvent for each of them.



Table2. detailed presentation of the chemical and biochemical compositions of the selected biomasses and selected item from Ecoinvent.

Category	Details *	Birch	Poplar	Willow
Chemical composition (%)	Carbon	49.1	49.4	50.2
	Hydrogen	6.4	6.0	6.2
	Oxygen	44.3	43.9	43.0
	Nitrogen	0.2	0.6	0.5
	Sulphur	0.1	0.02	0.04
	Moisture content	12.6	8.5	19
Biochemical composition (%)	Cellulose	40.7	46.2	38.5
	Hemicellulose	27.7	24.4	17.6
	Lignin	20.4	24.5	26.3
Ecoinvent, for the cultivation process	selected item	Hardwood forestry, birch, sustainable forest management; SE	Willow production, short rotation coppice; DE**	Willow production, short rotation coppice; DE

*More details on all the selected biomasses with detailed explanation can be found in the SI-Table2. Percentages are out of the dry matter, except for moisture, which is out of the total biomass.

**same item was selected in Ecoinvent for willow and poplar as the specific item for poplar does not exist, and after a careful study of the composition, it was concluded that the item can be used for both. The difference in the moisture content is considered in the process design and mass balance.



3.5. Land use changes

Land use changes was not specifically addressed in this work. It was only included to the extent it is included within the Ecoinvent processes, but as demonstrated in Javourez et al. (2022), land use changes are not consistently accounted for within the Ecoinvent database. This is a key limitation of the present work, but as the same biomasses are used for both scenarios, it would not change the comparison and affect the scenario similarly. Yet, the scenarios requiring more biomass would be more penalized (by accounting for land use changes), and this cannot be reflected herein.

3.6. Data Quality Requirements

Although it is not mentioned here specifically in this work, data selection is done in a manner that is complete, reliable, and representative of the selected geographical and time scope of this project. Various data quality requirement is used, for example the one suggested by the pedigree matrix or International Life Cycle Assessment Data System (ILCD).

3.7. Description of the scenarios

In this work, 3 general routes are discussed to produce bio-based phenol to be then utilized for insulation materials production. These 3 routes were selected after consulting with the industrial partner in this project. Several sub-groups and options are found and discussed for each of these routes, which provide the industry with several possibilities for (bio)phenol production. For all these 3 methods, insulation foam is produced from phenolic resins, and phenol is used to produce the phenolic resins. The difference is related to the phenol production route, and the processes involved to initially prepare the biomass/bio-oil.

Initially, the 3 cases and the details pertaining to each are mentioned here, and next, further details on the selected scenarios (in bold) are presented.

Case1. Fossil-based phenol production (conventional route)

Case2. Lignin-based phenol production

Case2.1. lignin as by-product of pulp and paper industry

Case 2.2. lignin-first biorefinery method

2.2.1. Reductive Catalytic Fractionation (RCF)

2.2.2. Aldehyde-Assisted Fractionation (AAF)

2.2.3. Organosolv Route

Case3. Bio-oil-based phenol production

3.1. direct conversion of bio-oil to bio-phenol

3.2. **Cumene route** for production of bio-phenol

In the following section, more details on the selected routes including the process flows and Life Cycle Inventories (LCI) are provided. The other possibilities are further discussed in the section titled “relevant alternative not addressed”. Due to the time limitations, these methods were not fully studied and compared to the other cases.

3.7.1. Baseline petrochemical scenario

Conventional method can be used for phenolic resin production using fossil fuels, and the insulation foam could be made from it, as shown in Figure 9.

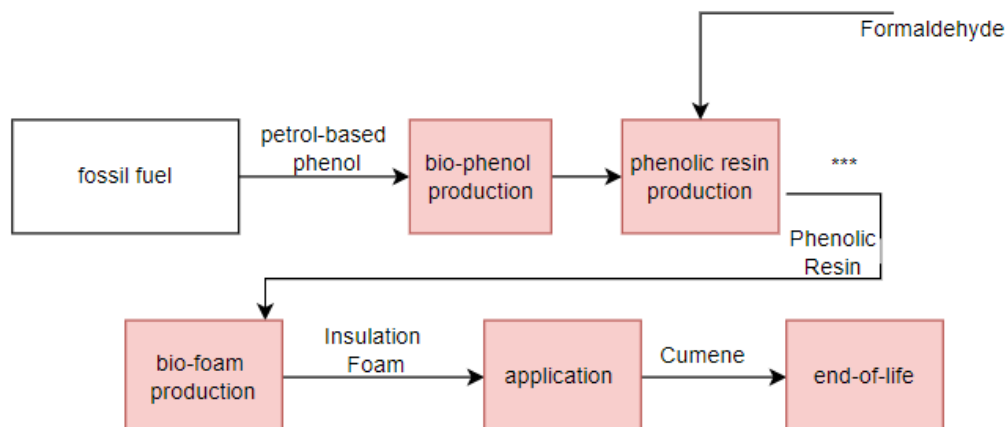

Figure 9. LCA system boundary of Fossil-based production of insulation foam. Boxes represent the key foreground processes, and arrows are flows. *** represents next steps coming after the phenol production. The red color represents processes and flow not addressed herein

3.7.2. Lignin scenario

For lignin-first approaches, crops are specifically cultivated to produce and utilize lignin and thus, crop cultivation and all the agricultural efforts, direct and indirect land use changes, water consumption, and fertilizer used are consequences of growing the biomass for this purpose. Therefore, these parameters would react to a change in demand, and this is simply why these steps should be considered for a consequential LCA for this scenario.

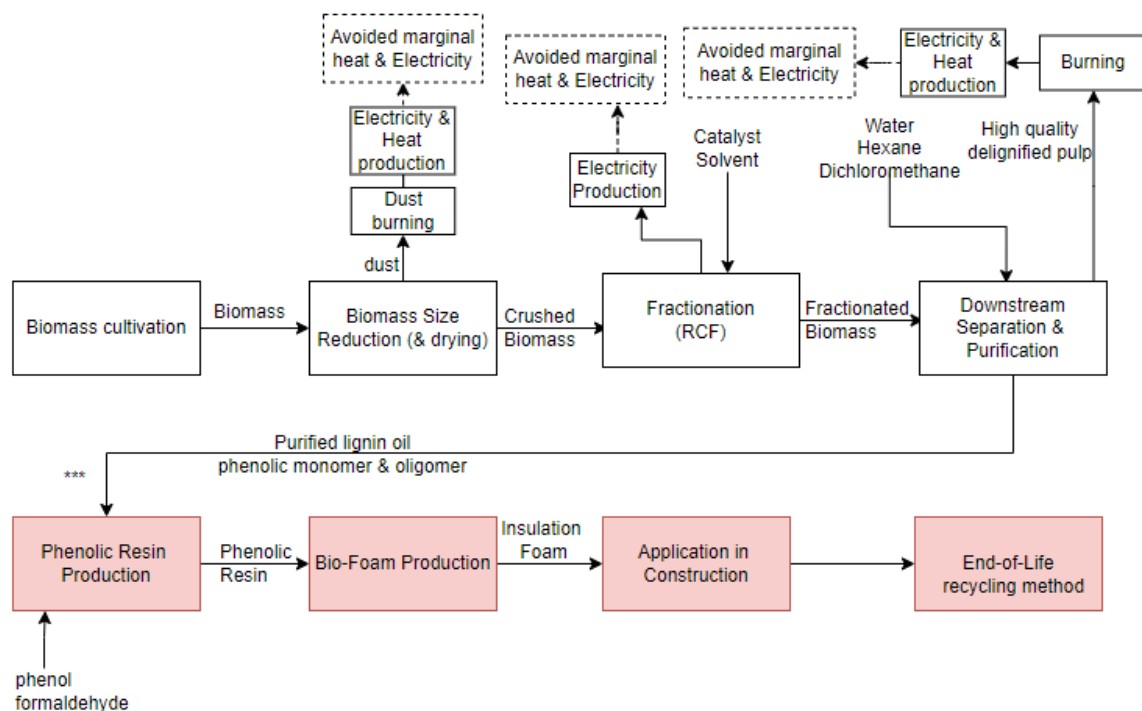

Figure 10. LCA system boundary of lignin separation through RCF method for insulation foam production. Boxes represent the key foreground processes, and arrows are flows. Full lines represent induced processes and flows, while dotted lines represent avoided ones. The red color represents processes and flow not addressed herein. For simplification and to avoid repetition, processes following the (***) sign will not be represented from here onwards.

Figure 10 demonstrates the process flow diagram of a RCF method, which is considered as a lignin-first approach that separates and purifies lignin. Then, purified lignin is used for phenolic resin production. In this process and the following processes, the same steps and chemicals are used starting



from phenolic resin production stage. For more simplification and to avoid repetition, processes with the same flow from this stage are just shown with *** and it represents the same pattern as shown in the Figure 10.

As shown in Figure 10, the selected biomass is cultivated and then, it is transported to the plant location. Based on the biomass moisture content and size, crushing and drying steps are designed to reach the desired properties for the next step. Then, the crushed biomass will enter the reactor, and the RCF reaction converts it to a high quality delignified pulp and lignin oil. In the separation and purification step, crude lignin oil is washed with water and extracted in dichloromethane. For the final purification, hexane is used to provide high quality phenolic monomer and oligomers (Tschulkow et al. 2020).

The final goal is to replace the petrol-based phenol, that is used for phenolic resin production, with the bio-based ones that are produced in this process. To have same properties and characteristics in the final resin, the maximum range of replacement could be from 20-30 wt% (25 wt% as an average) for the bio-based phenol (Jing et al. 2015)(Carvalho and Frollini 1999). This means only one-fourth of petrol-based phenol can be replaced with the high purity lignin oil and the remaining part is still coming from the petrol-based phenol. This is of great importance to note when comparing them to the other case studies and defining the Functional Unit for this study. In other words, **to avoid the production of 1 kg of petrol-based phenol, 4 kg of lignin oil is required..**

To produce the life cycle inventory of the RCF process itself (fractionation and separation steps), mass and energy balances were conducted based on two main references (Tschulkow et al. 2020)(Bartling et al. 2021). Accordingly, the emissions associated with each step were considered in the LCI. All the details, including the formulas used, logic behind all the calculations, and all the numbers for each step are separately presented in the SI.

The selected biomasses for RCF case study were chosen based on the review conducted on the recent papers in this field (summarized in the SI as Table1). Thus, the selected options are birch, willow, and poplar, which are the most studied, and there are already simulations and studies on these biomasses (Tschulkow et al. 2020)(Bartling et al. 2021).

The main by-products in this case are the dust generated in the drying and crushing steps and the delignified pulp from separation and purification units. There are several possibilities for the

valorization of the obtained pulp, but due to the time limitation, pulp and dust are burned (with heat and power recovery) in this work. Other possibilities for pulp valorization could also be studied like bioethanol production from cellulose and hemicellulose (Zhang et al. 2019), or paper production (Kumar et. al., 2017).

3.7.3. Bio-based oil scenario

In this scenario, bio-based phenol is produced from bio-based oil which comes from the biomass of choice. Bio-based phenol can replace 100% of the petrol-based phenol in the process of phenolic resin production. Figure 11.) demonstrates how the bio-based phenol can be applied to this process and similar to the previous cases, the resin production, foam production, application and end-of-life are not within the scope of the assessment.

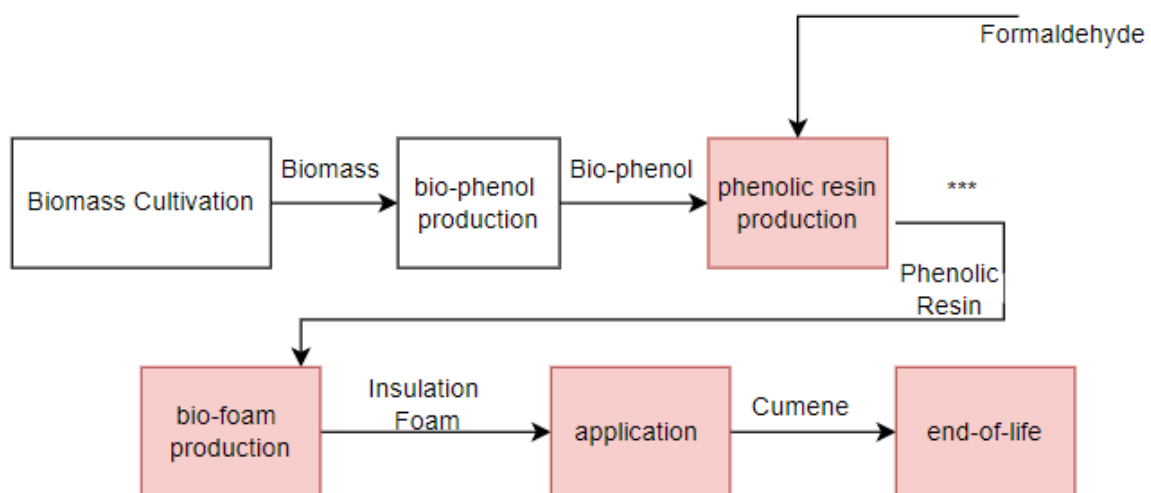

Figure 11. LCA system boundary of Bio-oil route for bio-based insulation foam production. Boxes represent the key foreground processes, and arrows are flows. Full lines represent induced processes and flows, while dotted lines represent avoided ones. The red color represents processes and flow not addressed herein.

To perform a better comparison, more information on the bio-based phenol production process was gathered. Biomass cultivation, bio-oil production through pyrolysis, benzene production, cumene production, and finally phenol production are the steps involved in this process (Miller, Armstrong, and Styring 2022). As the background data already exist for the benzene, cumene, and phenol



production, those were adapted to our case study. The key part was to select the best process for the conversion of bio-oil and then, benzene production. In a recent review study conducted by Millet et al., various methods for the benzene production were assessed and compared (Miller, Armstrong, and Styring 2022).

Among these methods, gasification is of low TRL (3), while processes that focus on pyrolysis have higher TRL (6). Another work patented by Anellotech in the US, showed the possibility of pyrolysis of biomass to obtain bio-oil, which is followed by the bio-oil cracking process (Anellotech, 2019). This pyrolysis route has a higher TRL (6) compared to the other alternatives. Another alternative is to gasify the woody biomass, and then to use Fischer-Tropsch to convert them to hydrocarbon. This option is done in the lab scale (TRL 4) by a Finish company called VTT (Reinikainen et al. 2015).

Miller et. al. (Miller, et. al., 2022), gathered information on 18 possibilities for renewable benzene production, and summarized the pros and cons of each. A comparison was made from People, Profit, and Planet (3P) point of views, and pyrolysis was ranked as the second-best option among all, and it had the highest TRL-6 (while the best option was only done in the lab scale, TRL 3).

After studying the different scenarios, pyrolysis is chosen as the selected route due to its higher TRL. Other reasons are based on Miller's work that showed pyrolysis is a favorable method from 3P point of view. The last reason justifying this option is the data availability; considering the time limitation of this internship, and the fact that some LCI information was already available in the team.

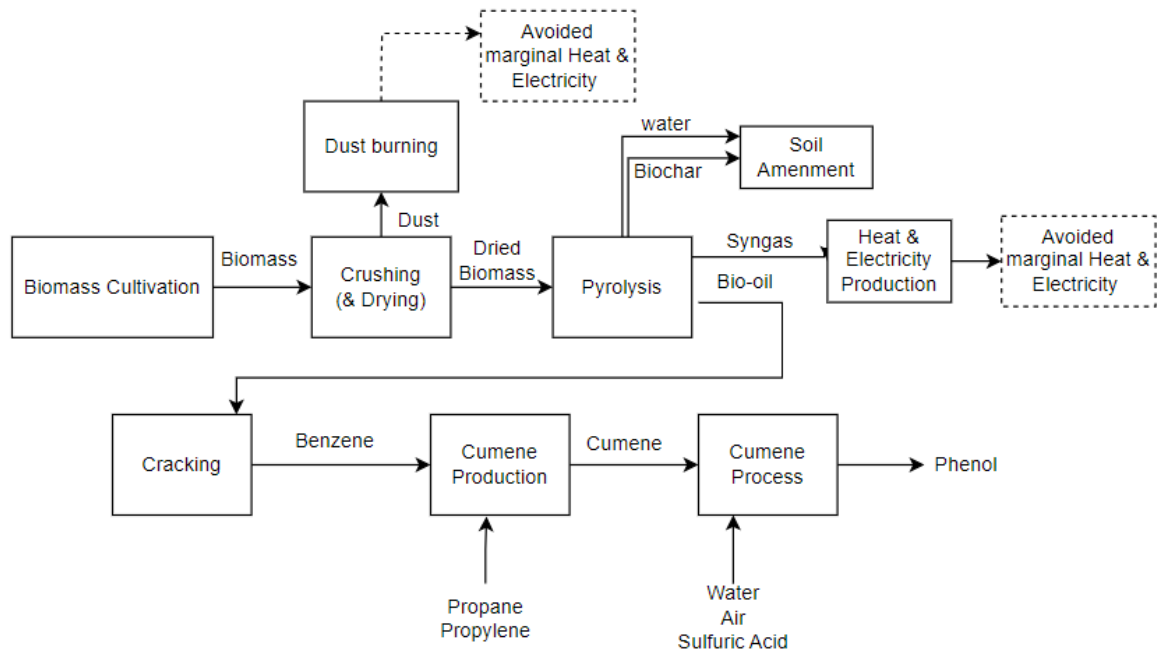

Figure 12. Process Flow Diagram and LCA system boundary of Bio-oil route for bio-based insulation foam production. Boxes represent the key foreground processes, and arrows are flows. Full lines represent induced processes and flows, while dotted lines represent avoided ones.

After selecting the bio-oil and benzene production route, more details on the process were determined. As shown in Figure 12, after biomass cultivation, it is crushed and dried to reach suitable conditions. Next, pyrolysis and cracking are done, which produces benzene, syngas, and biochar. The benzene would be then further used for the cumene production, and finally, phenol will be produced using cumene (Miller et. al., 2022). Since a consequential methodology is followed here, valorization methods should be considered for the by-products as well. Based on the work done by Brassard et. al. (Brassard et. al., 2021), biochar is used for the soil amendment purposes, and syngas is burnt in the CHP unit to produce heat and electricity, and consequently, avoided marginal heat and electricity production is also modelled in this work.

For this case study, 1 kg of bio-based phenol was selected as the reference flow as it can replace the petrol-based phenol 100%. This means to avoid the production of 1 kg of petrol-based phenolic resin, 1 kg of bio-based phenolic resin is required to be produced.



This production method is also called mass-balance method (bio-attribution) by the industry, in the sense that the company may not be sure whether the phenol used is bio-based or not, but by putting the demand for bio-based oil in the market, the company would be the incentive for more production of bio-oil and less consumption of fossil fuel.

3.7.4. Relevant Alternatives not addressed for the lignin case

Aldehyde-Assisted Fractionation (AAF)

This technology is further developed and studied by BL⁰Om Biorenewables (Biorenewable 2023). This company also contributes to the “ALIGNED” project, and they collaborate mostly in the WP1, focusing on the paper and pulp industry. In this study, AAF process is not included to prevent repeating what is done by our partner.

With AAF technology, lignin is efficiently separated from cellulose and hemicellulose, and unlike many other separation methods, lignin polymers are stabilized to prevent possible damages to their structure. This will enable the producers to fully valorize different fractions of biomass, and to use each part for high value-added application. The main steps involved in this process are preparation, fractionation, depolymerization & deoxygenation, and separation and purification (Biorenewable 2023).

Organosolv

Organosolv method is used to separate and extract lignin from lignocellulosic biomass using solvent solutions. This process operates normally in the temperature range of 180-220 °C (Chin et al. 2021). Compared to the other conventional methods, lignin obtained through the organosolv process has better quality. Moreover, the organic solvent can be recovered easily which is favorable from an environmental aspect (Zijlstra et al. 2020). As shown in Figure 13 after the separation and filtration process, the lignin oil could be used to replace the petrol-based phenol. The solid pulp obtained could be valorized in several ways like bioethanol production, or pulp and paper industry.

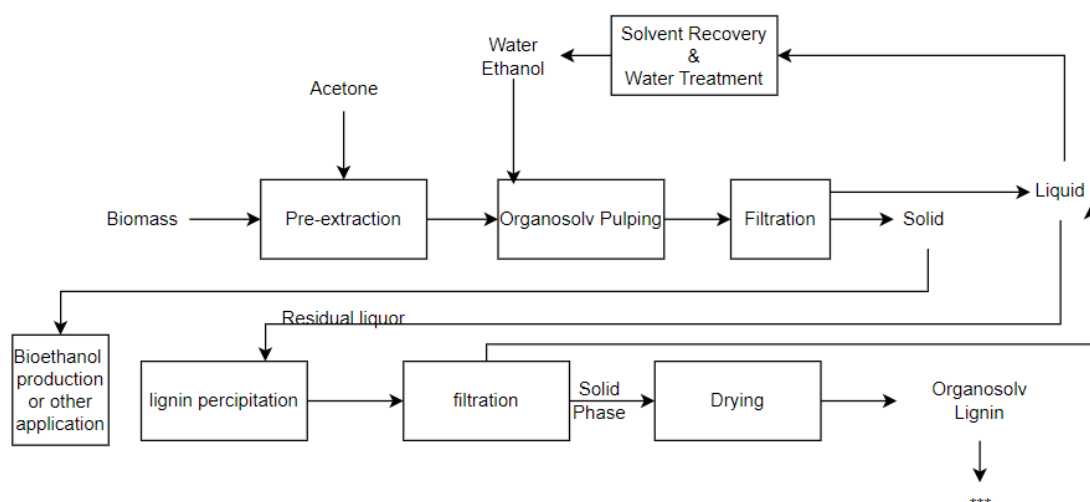

Figure 13. Process Flow Diagram and LCA system boundary of Organosolv lignin route for bio-based insulation foam production. Boxes represent the key foreground processes, and arrows are flows. Full lines represent induced processes and flows, while dotted lines represent avoided ones. ***: For more simplification and to avoid repetition, processes with the same flow from this stage are just shown with *** and it represents the same pattern as shown here***

Lignin as by-product of paper and pulp industry

In the second part of bio-based scenario, lignin as the by-product of paper and pulp industry could replace the phenol to produce phenolic resin. The process flow diagram is shown in Figure 14.

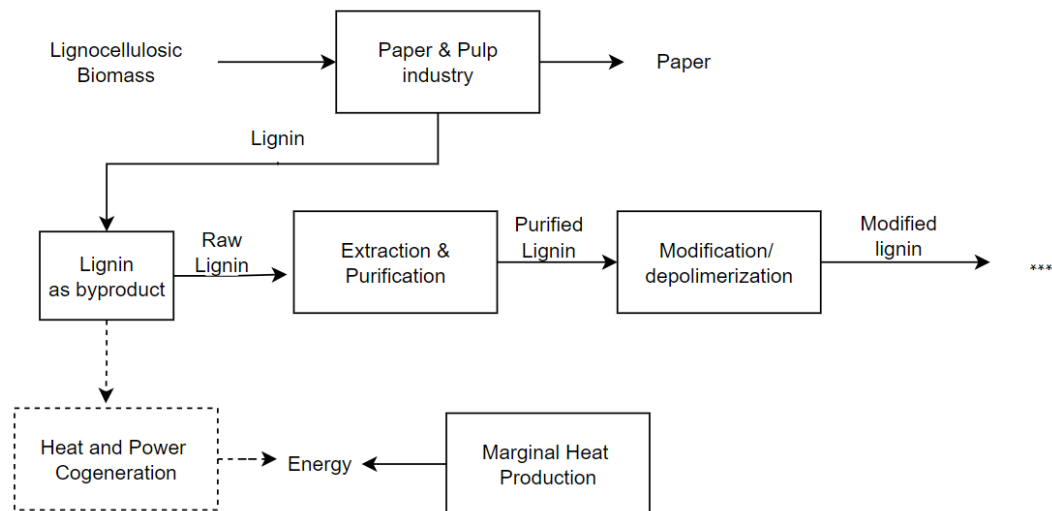

Figure 14. Process Flow Diagram and LCA system boundary of Lignin as by-product used for insulation foam production. Boxes represent the key foreground processes, and arrows are flows. Full lines represent induced processes and flows, while dotted lines represent avoided ones

For lignin as byproduct case, biomass cultivation is not considered since that doesn't react to the demand change and the main driver for biomass cultivation is a demand in paper and pulp industry. The conventional pulp and paper plants produce high quantities of lignin which is used for heat and power cogeneration. If this lignin is used for phenolic resin production, it is important to note that it cannot be used anymore for energy production purposes. Hence, marginal heat suppliers would react to this change since they will need to provide the energy that was provided with lignin previously.

In the paper and pulp industry, different methods are used for the separation of lignin and (hemi)cellulosic pulp. Since the main objective is to have high quality pulp to be further valorized, these processes drastically change the structure of lignin and affect its reactivity negatively (Sethupathy et al. 2022).

4. Results

This work studies the environmental impacts of six scenarios and compares the results for 6 impact categories. The results are depicted in the figure 15 to figure 20, for each of the impact category,



separately. In these figures, negative values show the avoided environmental impacts, while positive values are the created environmental impacts. All the values are measured and calculated based on the functional unit, which is 1 kg of avoided fossil-based phenol.

It is important to mention that the results presented in this section are not completed, since the research is still ongoing. One of the purposes of this work is to compare the lignin-based route with bio-oil routes, which requires the verified results of bio-oil case to be available as well. Due to the time limitations, the verified results only for lignin-case are available currently, and for the bio-oil case the data from Ecoinvent are mostly used which needs to be updated. (More specifically, the step for the conversion of bio-oil to the benzene needs to be updated as its fossil-based in the current data used and presented herein.) This is the main reason that more attention is paid to the lignin-based route in the result and discussion section.

4.1. Climate Change- Global Warming Impact

Figure 15 presents the climate change impact, expressed in global warming potential, over a horizon time of 100 years (GWP_{100}), itself translated into a CO_2 equivalent metric. Based on the results for global warming impact of different scenarios (shown in Figure 15. Global Warming Impact of the case studies), it is concluded that there is no big difference for different biomasses for this impact. The total impact for all the three lignin-based cases is negative, meaning that they have avoided impacts. It also implies that it is better to do this scenario, than not doing it at all. Another important issue to note is that all these three scenarios show the same pattern, as the most impactful processes are the same for all.

For the positive part, separation and purification step is the biggest contributor for all the cases, and almost 60% of the emission is in the form of CO_2 , reflecting the important electricity requirements. This is followed by pulp burning stage which has the second highest global warming impact, due to the emissions stemming from pulp burning. The third most polluting process in all the scenarios is also the same and is related to the biomass cultivation, which is essentially due to use of fertilizers. For the negative part, the biggest contributors are avoided high voltage electricity, and avoided low temperature heat, respectively. These avoided heat and electricity come from pulp valorisation (burning) and dust burning. The impact created from separation and purification step is almost the same as avoided low temperature heat and they compensate for each other. Marginal High

Voltage electricity and avoided low temperature account for 41-43% and 17.9-18.8% of the total impact, respectively.

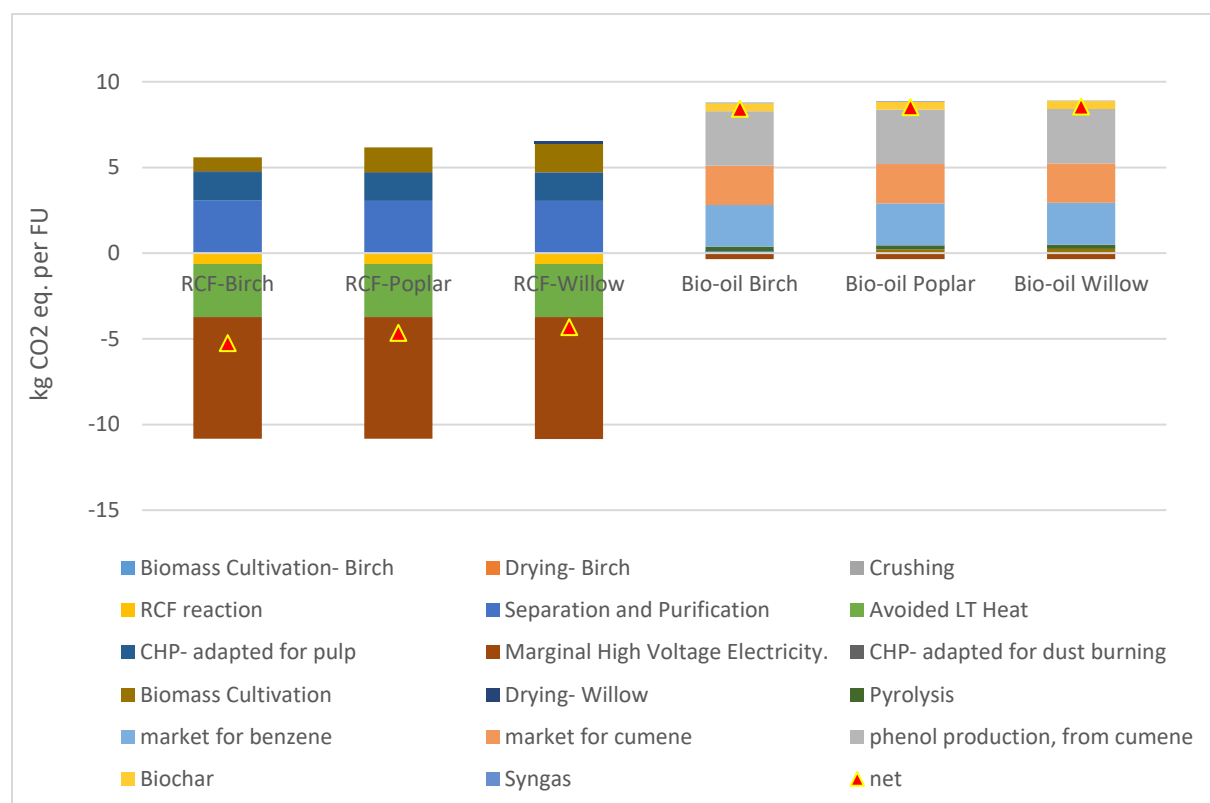

Figure 15. Global Warming Impact of the case studies, breakdown per process contribution. FU: functional unit (1 kg avoided fossil kerosene)

4.2. Eutrophication: Marine

According to Figure 16, the total impact for poplar and willow scenarios are positive, while the total impact for birch is negative. When looking at it more precisely, for poplar and willow cases, the biggest contribution is related to the biomass cultivation. On the other hand, the biomass cultivation for birch case is almost half of the 2 other cases. This is due to the fact that less fertilizer is applied for birch cultivation compared to the two other crops. Moreover, RCF process and marginal high voltage electricity is negative for all the three cases, and they are the two biggest contributors of the negative

impact. Unlike the global warming impact, pulp burning process does not contribute to the eutrophication marine impact significantly.

The ratios are almost the same for the 3 biomasses and RCF reaction and high voltage electricity are 40-42% and 52% of the avoided marine eutrophication impact. As detailed in the SI.Table2 for the RCF reaction. Nitrogen is needed as an input to the RCF reactor.

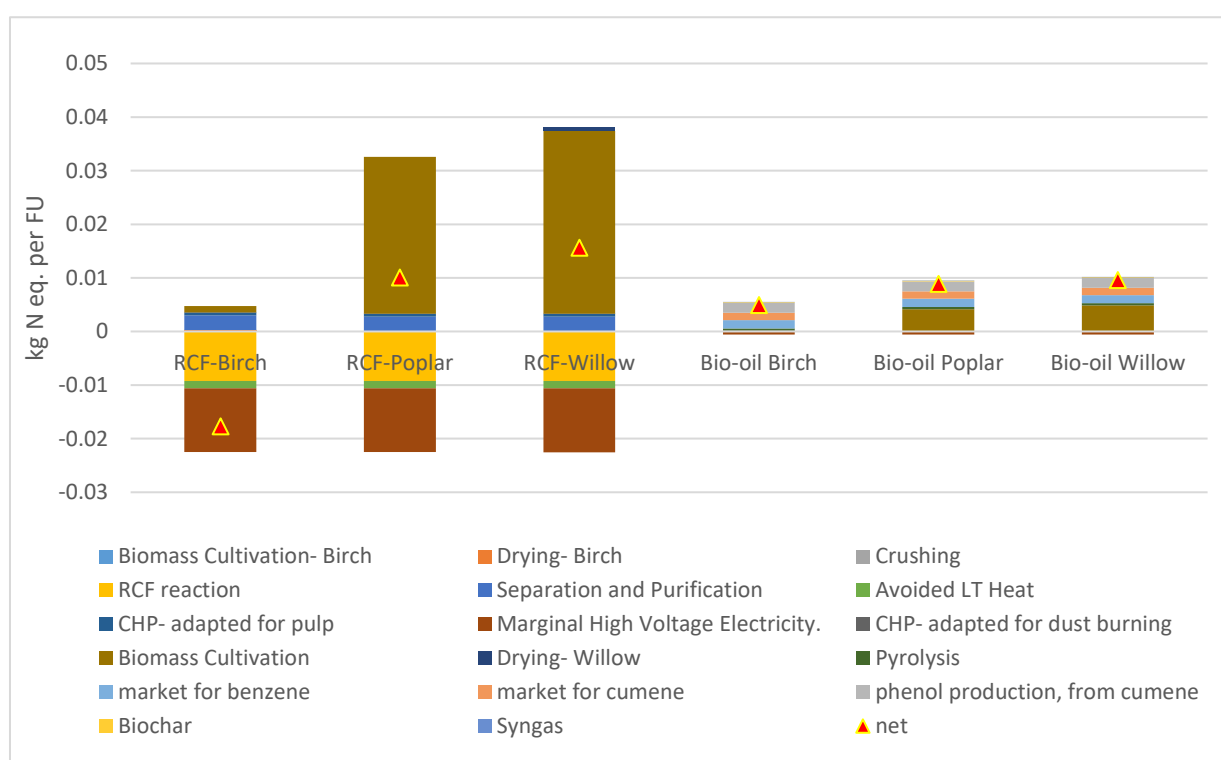

Figure 16. Eutrophication: Marine contribution of the case studies, breakdown per process contribution. FU: functional unit (1 kg avoided fossil kerosene)

4.3. Eutrophication: Fresh Water

As shown in Figure 17, the total eutrophication: freshwater impact is negative for all the 3 lignin-based cases. The values are very close for different scenarios with no meaningful differences. The most impactful negative processes are RCF and high voltage marginal electricity. For the RCF, this reflects the high water consumption at this stage. Similar to the marine eutrophication, biomass cultivation is the biggest positive contributor and its more highlighted for the willow and poplar cases. Based on the calculations and results obtained from Activity Browser, RCF is the biggest

contributor compared to all the process involved, and for all the 3 biomasses it forms 91.5% of the total freshwater impacts.

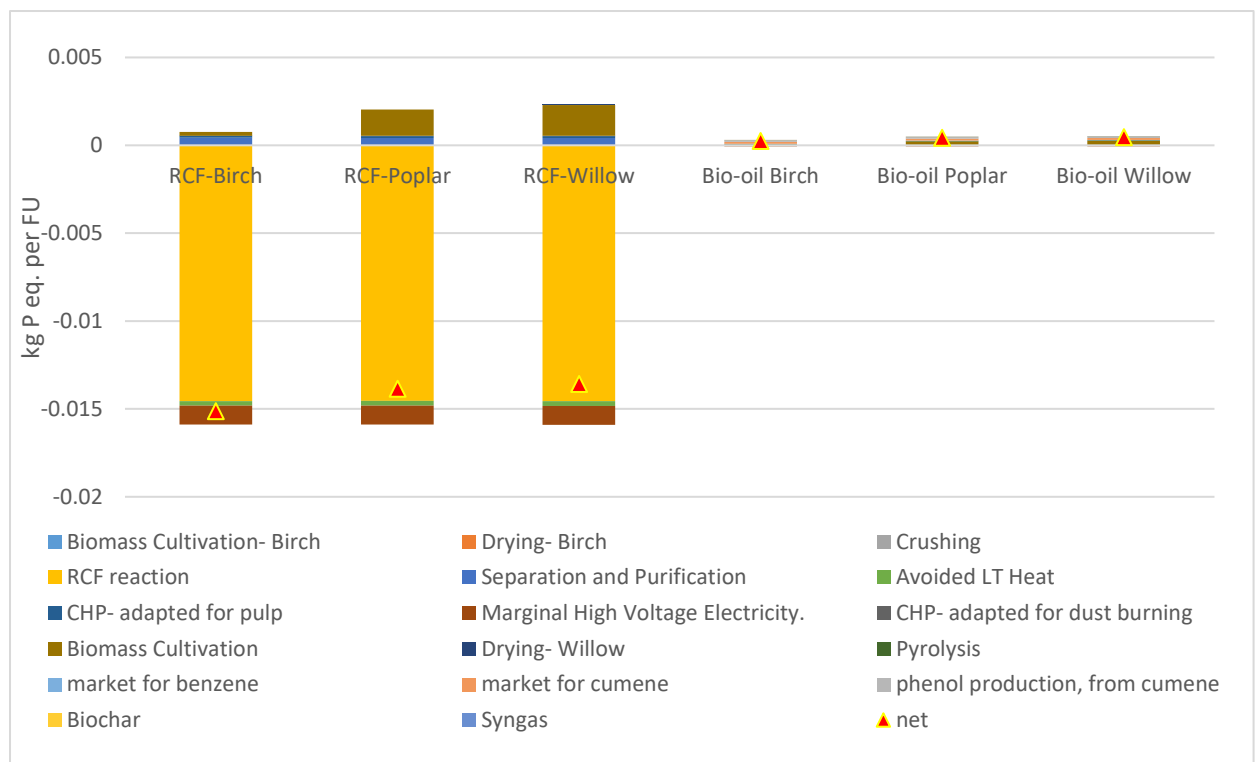

Figure 17. Eutrophication: freshwater impact of case studies, breakdown per process contribution. FU: functional unit (1 kg avoided fossil kerosene)

4.4. Land Use

For the land use impacts, the same pattern is observed for all the lignin-based scenarios. The two main highlighted contributors to the negative impact for land use are marginal high voltage electricity and RCF reaction. On the other hand, the main contributor for the positive impact is associated with biomass cultivation for all the cases. The total impact for willow and poplar case are negative, while birch case has a positive land use impact.

For this impact, biomass cultivation shows up to 97% of the total land use impacts created, which is almost the same percentage ($\pm 0.5\%$) for all the 3 biomasses. On the other hand, high voltage electricity is 79% of the total avoided land use impact.

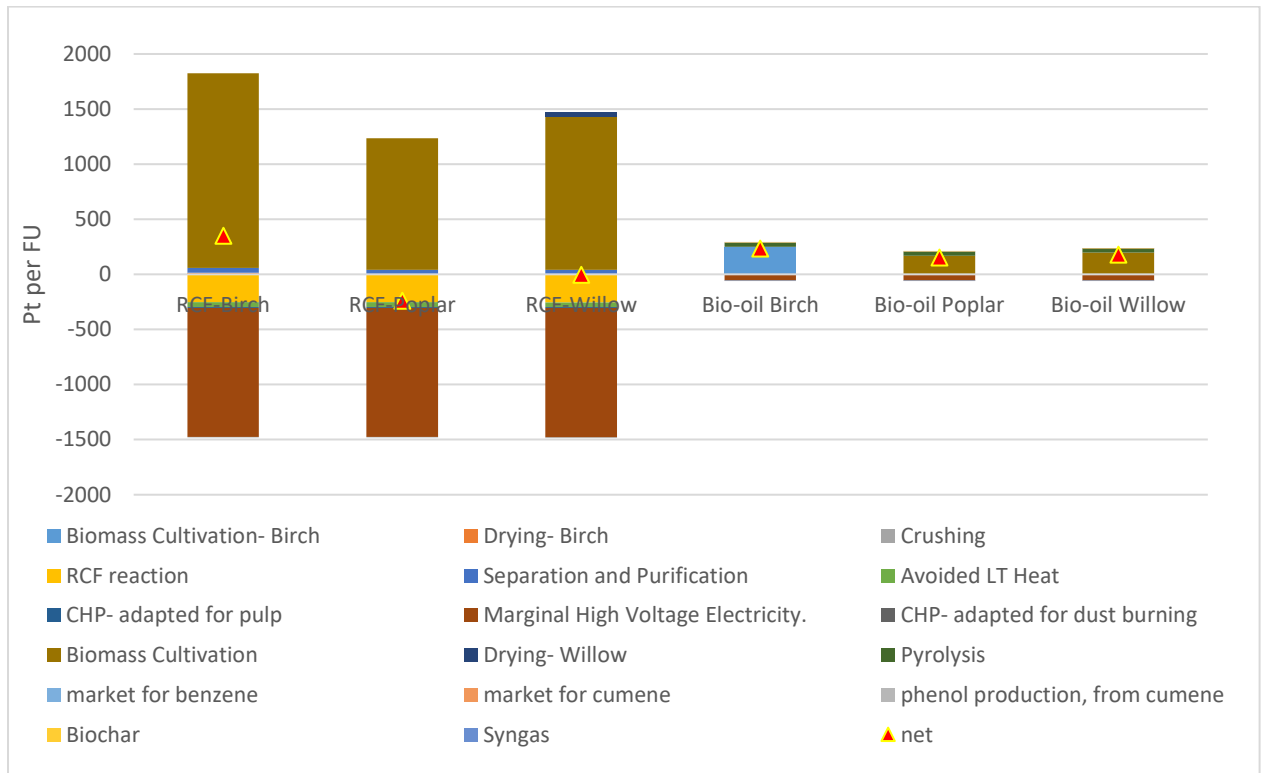

Figure 18. Land Use of the case studies, breakdown per process contribution. FU: functional unit (1 kg avoided fossil kerosene)

4.5. Water Use

Figure 19 shows the water use associated with each case study and the RCF step is the most water demanding stage for all these cases. On the other hand, the 2 biggest negative contributors for water use are avoided high voltage electricity and avoided low temperature.

Based on the result from activity browser, avoided low temperature and high voltage electricity contributes 65% and 34% to the total avoided impact of water use for the cases studied. Moreover, RCF is the main contributor and it form 84-91% of total water use impact.

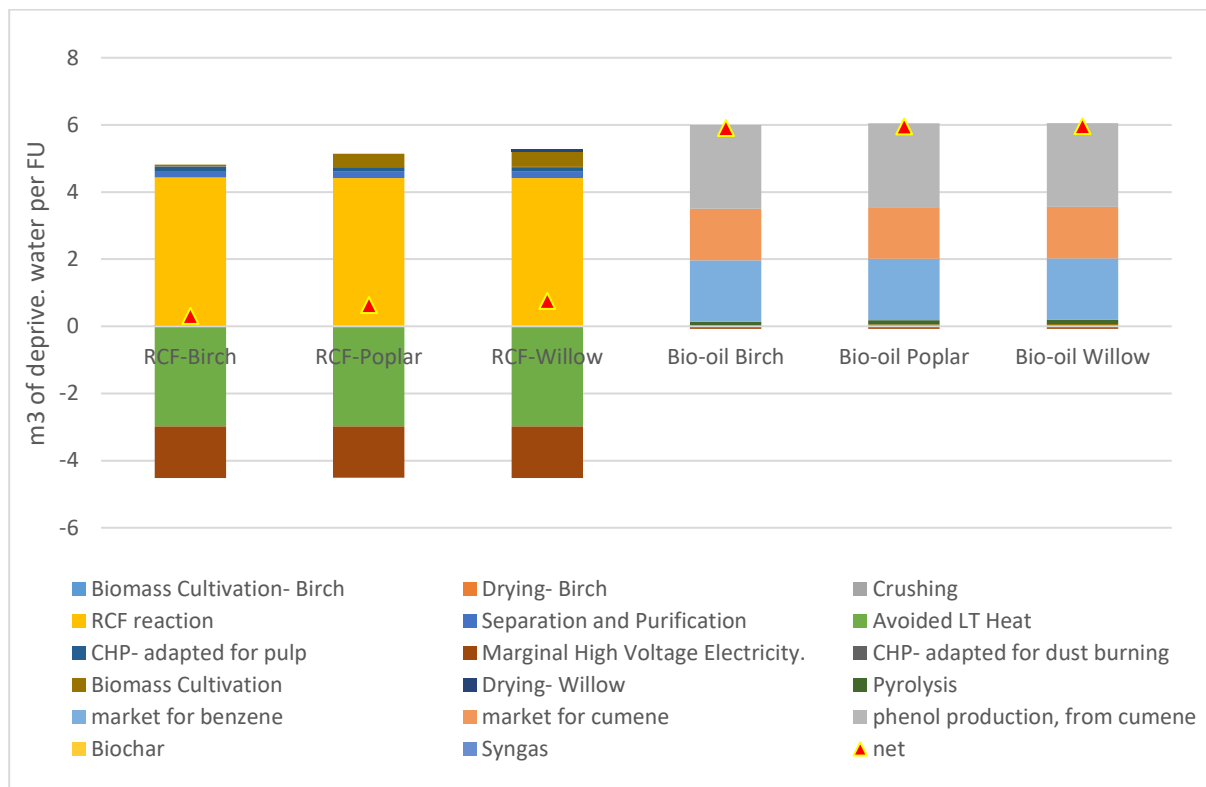

Figure 19. Water use of the case studies, breakdown per process contribution. FU: functional unit (1 kg avoided fossil kerosene)

4.6. Particulate Matter

The total impact for all the three lignin-based scenarios is positive and there is not any notable difference between these cases. The most impactful process for all the three cases is the same and it is the RCF reaction. This is mostly due to the SO₂ emissions from RCF step. The second biggest one is separation and purification unit, but compared to the RCF reaction it is 15-20 times smaller.

. RCF reaction is almost 91% of the created impact, while high voltage electricity forms 92% of the avoided impacts.

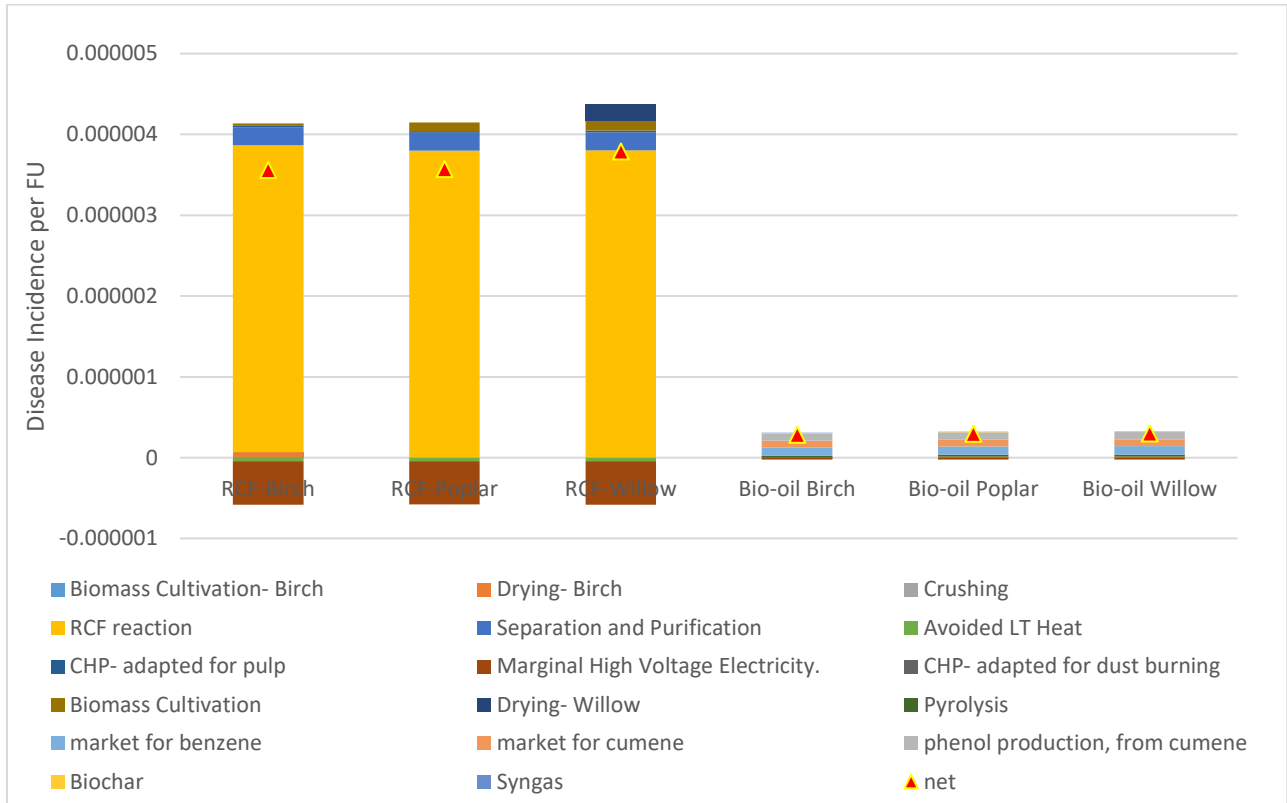

Figure 20. Particulate Matter impact of the case studies, breakdown per process contribution. FU: functional unit (1 kg avoided fossil kerosene)

Table 3. detailed interpretation and breakdown of each impact category for 1 FU of lignin oil production.

Impact category	Main unit process	Elementary-flow level contribution
Climate change (GWP100)	Separation & purification unit (49%)	CO ₂ (60%) N ₂ O (20%) CH ₄ (15%)
	Pulp burning (29%)	CO ₂ (40%) N ₂ O (25%) CH ₄ (20%)
Eutrophication: freshwater	Biomass Cultivation (73%)	Phosphorus (55%) Phosphate (30%)
Eutrophication: marine	Biomass cultivation (89%)	NO _x (90%)



Water use	RCF reaction (85%)	Water (85%)
Particulate Matter	RCF reaction (91%)	SO ₂ (80%)
Land use	Biomass cultivation (96%)	Occupation, intensive forest (85%)

5. Conclusion and discussion

This research aimed to find the routes for the production of bio-phenol and make a comparison with the use of consequential life cycle assessment, to distinguish the best pathways from an environmental performance point of view. Due to the time limitation, and infancy of the technologies studied, the work still shows potential for further improvements.

Initially, different possibilities were studied to find alternatives to the petrol-based phenol. These options were categorized into lignin-first and bio-oil pathways. For each of these categories, sub-groups were found, and more specifically, RCF, AAF, and organosolv were presented as three lignin-first methods. Both for the lignin-first and bio-oil scenarios, the process flow was found through literature review and based on previous works conducted in the field.

After development and assessing various possibilities, RCF and bio-oil scenarios were selected to be further studied, and to conduct the LCA for these methods. Next, the detailed process flow was identified for each, followed by the mass and energy balances for both. Biomasses were selected based on the previous works, which are birch, willow, and poplar. LCI was done and needed information were gathered and completed so that the impact assessment could be done.

After completion of the process development and LCI step, the modelling was done through activity browser. Six impact categories were studied including: Global Warming Potential (GW100), eutrophication: marine, eutrophication: fresh water, land use, water use, and particulate matter. For all these impact categories, the results are presented for all the biomasses.

Among the 6 impact categories studied here, Biomass cultivation and RCF reaction were the ones that appeared as the main contributors three and two times, respectively. Based on table3, these two steps



are considered as the hot spots of the process, and further works can be done to improve their environmental impacts. RCF reaction is still not very well-developed and thus, further research and studies are needed to make the process more efficient and less polluting.

One of the key conclusions from this work is that (as shown in the result), there is no meaningful difference from an environmental performance point of view between birch, poplar, and willow, when they are used as the raw material for RCF process. Marine Eutrophication is the only impact category in which birch showed to have a better impact compared to the 2 other raw materials. The ultimate goal of this project was to also include all the results for bio-oil case study, and finally, to make a comparison between the lignin-oil and bio-oil cases. This would provide insight on the positive and negative sides of each processes, and after a careful comparison, the preferred one will be introduced. As this internship is still ongoing, these steps will be covered in the coming weeks.

6. Outlook

One of the main challenges encountered in this project was the time limitation. In the literature review step, several other possibilities and valorisation routes were identified, that could be considered as an alternative pathway and further studied.

- One of the scenarios described in this work is to use the lignin which is available as by-product of paper and pulp industry. This lignin is considered as residues, and it would be interesting to conduct an LCA study using this lignin as the raw material, even if it cannot react to a demand change, for the purpose to make a comparison between that and the current studied options.
- Similarly, for the bio-oil case study, tall oil could be utilized directly which is a by-product of paper and pulp industry. At the end, a comparison could be made between tall oil and our case studies.
- In the lignin-first methods, cellulose and hemicellulose are considered as by-products, and there are many ways to valorise these components. Common ways are bioethanol production (Bartling et al. 2021), paper production, heat and electricity production through burning, or food and feed industries (Sethupathy et al. 2022). Finally, it would be interesting to conduct the LCI for all these cases, and then, make a sensitivity analysis and comparison to see under different situations which of these valorisation methods are more profitable and environmentally friendly.



- It was found in the literature that in some studies (in the experimental level with low TRL), researchers tried to replace bio-oil directly with phenol to produce phenolic resin. In this work, this was done through production of benzene and cumene as intermediates in the process. It is interesting to conduct a LCA study on the direct use of bio-oil and make a comparison with the studied cases (Zhu et al. 2018).
- Land use changes associated with the woody biomass can be considered separately for the future works, and the land use for different types of crops and specific agricultural practices can be taken into consideration.
- As previously mentioned, cellulosic pulp is the by-product of the RCF method, and it is of huge importance how to valorise it. Aside from the conventional methods that are found in the literature, another idea is to extract aromatic from cellulose. Based on two recent works done by Dai et. al., (Dai et al. 2018) and Yang et. al., (Yang et al. 2019), this work has already been done, and it is interesting to consider this valorisation pathway and make a comparison between this and other common routes. The idea is more interesting specifically for this work, since it combines the first and second routes as it separates lignin to make lignin oil, and at the same time it utilizes cellulose to produce bio-phenol through benzene and cumene route.

7. References

- Abdelwahab, N A, and M A Nassar. 2011. "Preparation, Optimisation and Characterisation of Lignin Phenol Formaldehyde Resin as Wood Adhesive." *Pigment & Resin Technology*.
- "Anellotech, 2019. Bio-TCat™ for Renewable Chemicals & Fuels. Available." 2019. 2019.
- Aseeva, Roza Mikhaïlovna. 2004. *Handbook of Polymeric Foams and Foam Technology*. Hanser Verlag.
- Ashida, Kaneyoshi. 2006. *Polyurethane and Related Foams: Chemistry and Technology*. CRC press.
- Azadi, Pooya, Oliver R Inderwildi, Ramin Farnood, and David A King. 2013. "Liquid Fuels,



Hydrogen and Chemicals from Lignin: A Critical Review.” *Renewable and Sustainable Energy Reviews* 21: 506–23.

Banu, J Rajesh, S Kavitha, R Yukesh Kannah, T Poornima Devi, M Gunasekaran, Sang-Hyoun Kim, and Gopalakrishnan Kumar. 2019. “A Review on Biopolymer Production via Lignin Valorization.” *Bioresource Technology* 290: 121790.

Barañano, Leire, Naroa Garbisu, Itziar Alkorta, Andrés Araujo, and Carlos Garbisu. 2021. “Contextualization of the Bioeconomy Concept through Its Links with Related Concepts and the Challenges Facing Humanity.” *Sustainability* 13 (14): 7746.

Bartling, Andrew W, Michael L Stone, Rebecca J Hanes, Arpit Bhatt, Yimin Zhang, Mary J Bidy, Ryan Davis, Jacob S Kruger, Nicholas E Thornburg, and Jeremy S Luterbacher. 2021. “Techno-Economic Analysis and Life Cycle Assessment of a Biorefinery Utilizing Reductive Catalytic Fractionation.” *Energy & Environmental Science* 14 (8): 4147–68.

Biorenewable, Bloom. 2023. “Bloom Maximizes the Usage of Plant Material with Cutting-Edge Science.” 2023. <https://www.bloombiorenewables.com/technology>.

Bosch, Sander Van den, Tom Renders, S Kennis, S-F Koelewijn, Gil Van den Bossche, Thijs Vangeel, Aron Deneyer, D Depuydt, C M Courtin, and J M Thevelein. 2017. “Integrating Lignin Valorization and Bio-Ethanol Production: On the Role of Ni-Al₂O₃ Catalyst Pellets during Lignin-First Fractionation.” *Green Chemistry* 19 (14): 3313–26.

Brandão M, Weidema B P, Martin M, Cowie A, Hamelin L, Zamagni A (2022). 2022. “Consequential Life Cycle Assessment: What, Why and How?” 2022. <https://lca-net.com/publications/show/consequential-life-cycle-assessment-what-why-and-how/>.

Brassard, Patrick, Stéphane Godbout, and Lorie Hamelin. 2021. “Framework for Consequential Life Cycle Assessment of Pyrolysis Biorefineries: A Case Study for the Conversion of Primary Forestry Residues.” *Renewable and Sustainable Energy Reviews* 138: 110549.

Carvalho, Gil de, and Elisabete Frollini. 1999. “Lignin in Phenolic Foams 66.” *Polímeros* 9 (1): 66–75.

Chin, Danny Wei Kit, Steven Lim, Yean Ling Pang, Chun Hsion Lim, Siew Hoong Shuit, Kiat Moon Lee, and Cheng Tung Chong. 2021. “Effects of Organic Solvents on the Organosolv Pretreatment of Degraded Empty Fruit Bunch for Fractionation and Lignin Removal.” *Sustainability* 13 (12): 6757.

Comission, European. 2013. “A Bioeconomy Strategy for Europe.” In . <https://doi.org/10.2777/17708>.

Commission, European. 2020. “EU Reference Scenario 2020.” 2020. https://energy.ec.europa.eu/data-and-analysis/energy-modelling/eu-reference-scenario-2020_en.

———. 2021. “On the Use of the Environmental Footprint Methods to Measure and Communicate the Life Cycle Environmental Performance of Products and Organisations.” https://environment.ec.europa.eu/system/files/2021-12/Commission Recommendation on the use of the Environmental Footprint methods_0.pdf.



Consulting, SRI. 2013. "World Petrochemical (WP) Report on PF Resins."
http://www.sriconsulting.com/WP/Public/Reports/pf_resins/.

Dai, Gongxin, Shurong Wang, Qun Zou, and Shuqiong Huang. 2018. "Improvement of Aromatics Production from Catalytic Pyrolysis of Cellulose over Metal-Modified Hierarchical HZSM-5." *Fuel Processing Technology* 179: 319–23.

Dickinson, Eric. 1992. *Introduction to Food Colloids*. Oxford university press.

Doherty, William O S, Payam Mousavioun, and Christopher M Fellows. 2011. "Value-Adding to Cellulosic Ethanol: Lignin Polymers." *Industrial Crops and Products* 33 (2): 259–76.

Eckelman, Carl A. 1999. *Brief Survey of Wood Adhesives*. Purdue University Cooperative Extension Service West Lafayette.

"Ecoinvent v3.9.1." 2022. 2022. <https://ecoinvent.org/the-ecoinvent-database/data-releases/ecoinvent-3-9-1/>.

Federica Pozzi. 2022. "Why Construction Matters."

"Forecast of Global Phenolic Foam Board Market 2023." 2019.
www.marketresearchreports.com.

Gao, Cheng, Ming Li, Chenjie Zhu, Youqin Hu, Tao Shen, Mengyu Li, Xingxiang Ji, Gaojin Lyu, and Wei Zhuang. 2021. "One-Pot Depolymerization, Demethylation and Phenolation of Lignin Catalyzed by HBr under Microwave Irradiation for Phenolic Foam Preparation." *Composites Part B: Engineering* 205: 108530.

Gao, Zhiwen, Xueling Lang, Shuang Chen, and Chen Zhao. 2021. "Mini-Review on the Synthesis of Lignin-Based Phenolic Resin." *Energy & Fuels* 35 (22): 18385–95.

Gardziella, Arno, Louis A Pilato, and Andre Knop. 2013. *Phenolic Resins: Chemistry, Applications, Standardization, Safety and Ecology*. Springer Science & Business Media.

Hattali, Samir, Ahmed Benaboura, Stéphane Dumarçay, and Philippe Gérardin. 2005. "Evaluation of Alfa Grass Soda Lignin as a Filler for Novolak Molding Powder." *Journal of Applied Polymer Science* 97 (3): 1065–68.

Hu, Xiang-Ming, Yan-Yun Zhao, and Wei-Min Cheng. 2015. "Effect of Formaldehyde/Phenol Ratio (F/P) on the Properties of Phenolic Resins and Foams Synthesized at Room Temperature." *Polymer Composites* 36 (8): 1531–40.

"ISO 14040:2006, Environmental Management — Life Cycle Assessment — Principles and Framework." 2006. 2006. <https://www.iso.org/standard/37456.html>.

Jing, Zhou, Hu Lihong, Liang Bingchuan, Bo Caiying, Jia Puyou, and Zhou Yonghong. 2015. "Preparation and Characterization of Novolac Phenol–formaldehyde Resins with Enzymatic Hydrolysis Lignin." *Journal of the Taiwan Institute of Chemical Engineers* 54: 178–82.

Kloekhorst, Arjan, and Hero Jan Heeres. 2015. "Catalytic Hydrotreatment of Alcell Lignin Using Supported Ru, Pd, and Cu Catalysts." *ACS Sustainable Chemistry & Engineering* 3 (9): 1905–14.



Korányi, Tamás I, Bálint Fridrich, Antonio Pineda, and Katalin Barta. 2020. "Development of 'Lignin-First' Approaches for the Valorization of Lignocellulosic Biomass." *Molecules* 25 (12): 2815.

Kumar, Hemanathan, and Lew P Christopher. 2017. "Recent Trends and Developments in Dissolving Pulp Production and Application." *Cellulose* 24: 2347–65.

Lecompte, Thibaut. 2022. "Bio-Based Materials Improve the Comfort and Carbon Footprint of Buildings." <https://www.polytechnique-insights.com/en/columns/planet/bio-based-materials-improve-the-comfort-and-carbon-footprint-of-buildings/#note-11>.

Li, Hongwei, Bing Li, Zhongshun Yuan, Yongsheng Zhang, and Chunbao Charles Xu. 2022. "Synthesis of Bio-/Lignin-Based Phenolic Foams for Insulation and Floral Applications." In *Phenolic Based Foams: Preparation, Characterization, and Applications*, 253–74. Springer.

Li, Tian, Jianwei Song, Xinpeng Zhao, Zhi Yang, Glenn Pastel, Shaomao Xu, Chao Jia, Jiaqi Dai, Chaoji Chen, and Amy Gong. 2018. "Anisotropic, Lightweight, Strong, and Super Thermally Insulating Nanowood with Naturally Aligned Nanocellulose." *Science Advances* 4 (3): eaar3724.

Mansouri, Nour Eddine El, Qiaolong Yuan, and Farong Huang. 2018. "Preparation and Characterization of Phenol-Formaldehyde Resins Modified with Alkaline Rice Straw Lignin." *BioResources* 13 (4): 8061–75.

McCormick, Kes, and Niina Kautto. 2013. "The Bioeconomy in Europe: An Overview." *Sustainability* 5 (6): 2589–2608.

Miller, David, Katy Armstrong, and Peter Styring. 2022. "Assessing Methods for the Production of Renewable Benzene." *Sustainable Production and Consumption* 32: 184–97.

Mougel, C, T Garnier, P Cassagnau, and N Sintès-Zydowicz. 2019. "Phenolic Foams: A Review of Mechanical Properties, Fire Resistance and New Trends in Phenol Substitution." *Polymer* 164: 86–117.

"Paris Agreement." 2015. https://unfccc.int/sites/default/files/english_paris_agreement.pdf.

"Phyllis2." n.d. <https://phyllis.nl/Browse/Standard/ECN-Phyllis#>.

Pilato, Louis. 2010a. *Phenolic Resins: A Century of Progress*. Vol. 11. Springer.

———. 2010b. "Resin Chemistry." *Phenolic Resins: A Century of Progress*, 41–91.

Reinikainen, Matti, David Thomas, Pekka Simell, and Ikka Hannula. 2015. "Pure Aromatics from Biomass."

Renders, Tom, Sander Van den Bosch, S-F Koelewijn, Wouter Schutyser, and B F Sels. 2017. "Lignin-First Biomass Fractionation: The Advent of Active Stabilisation Strategies." *Energy & Environmental Science* 10 (7): 1551–57.

Sandhya, P K, Meyyarappallil Sadasivan Sreekala, and Sabu Thomas. 2022. *Phenolic Based Foams: Preparation, Characterization, and Applications*. Springer Nature.



- Schutyser, W, ab T Renders, S Van den Bosch, S-F Koelewijn, G T Beckham, and Bert F Sels. 2018. "Chemicals from Lignin: An Interplay of Lignocellulose Fractionation, Depolymerisation, and Upgrading." *Chemical Society Reviews* 47 (3): 852–908.
- Sethupathy, Sivasamy, Gabriel Murillo Morales, Lu Gao, Hongliang Wang, Bin Yang, Jianxiong Jiang, Jianzhong Sun, and Daochen Zhu. 2022. "Lignin Valorization: Status, Challenges and Opportunities." *Bioresource Technology*, 126696.
- Siddiqui, Homaira. 2013. *Production of Lignin-Based Phenolic Resins Using de-Polymerized Kraft Lignin and Process Optimization*. The University of Western Ontario (Canada).
- Siddiqui, Homaira, Nubla Mahmood, Zhongshun Yuan, Ferdinando Crapulli, Luana Dessbesell, Amin Rizkalla, Ajay Ray, and Chunbao Xu. 2017. "Sustainable Bio-Based Phenol-Formaldehyde Resoles Using Hydrolytically Depolymerized Kraft Lignin." *Molecules* 22 (11): 1850.
- Song, Seung A, Yong Sik Chung, and Seong Su Kim. 2014. "The Mechanical and Thermal Characteristics of Phenolic Foams Reinforced with Carbon Nanoparticles." *Composites Science and Technology* 103: 85–93.
- "SPECIAL REPORT-Global Warming of 1.5 °C." n.d. Accessed April 20, 2023. <https://www.ipcc.ch/sr15/>.
- Steffen, Will, Katherine Richardson, Johan Rockström, Sarah E Cornell, Ingo Fetzer, Elena M Bennett, Reinette Biggs, Stephen R Carpenter, Wim De Vries, and Cynthia A De Wit. 2015. "Planetary Boundaries: Guiding Human Development on a Changing Planet." *Science* 347 (6223): 1259855.
- Sun, Zhuohua, Bálint Fridrich, Alessandra De Santi, Saravanakumar Elangovan, and Katalin Barta. 2018. "Bright Side of Lignin Depolymerization: Toward New Platform Chemicals." *Chemical Reviews* 118 (2): 614–78.
- "The European Construction Sector - A Global Partner." 2016. <https://ec.europa.eu/docsroom/documents/15866/attachments/1/translations>.
- Tonge, Livia, and B Eng. 2007. *Thermochemical Properties of Methylol Phenol Monomers and Phenol Formaldehyde Resoles*. Swinburne University of Technology, Faculty of Engineering and Industrial
- Tschulkow, Maxim, Tine Compernelle, Sander Van den Bosch, Joost Van Aelst, Ilié Storms, Miet Van Dael, Gil Van den Bossche, Bert Sels, and Steven Van Passel. 2020. "Integrated Techno-Economic Assessment of a Biorefinery Process: The High-End Valorization of the Lignocellulosic Fraction in Wood Streams." *Journal of Cleaner Production* 266: 122022.
- Wang, Mingcun, Mathew Leitch, and Chunbao Charles Xu. 2009. "Synthesis of Phenol-formaldehyde Resol Resins Using Organosolv Pine Lignins." *European Polymer Journal* 45 (12): 3380–88.
- Xiao, Wenya, Zhixiong Huang, and Jie Ding. 2017. "The Mechanical and Thermal Characteristics of Phenolic Foam Reinforced with Kaolin Powder and Glass Fiber Fabric." In *IOP Conference Series: Materials Science and Engineering*, 274:12013. IOP



Publishing.

Yang, Mingfa, Jingai Shao, Haiping Yang, Kuo Zeng, Zhengshun Wu, Yingquan Chen, Xiaowei Bai, and Hanping Chen. 2019. "Enhancing the Production of Light Olefins and Aromatics from Catalytic Fast Pyrolysis of Cellulose in a Dual-Catalyst Fixed Bed Reactor." *Bioresource Technology* 273: 77–85.

Zhang, Jingzhi, Jiao Liu, Linfeng Kou, Xu Zhang, and Tianwei Tan. 2019. "Bioethanol Production from Cellulose Obtained from the Catalytic Hydro-Deoxygenation (Lignin-First Refined to Aviation Fuel) of Apple Wood." *Fuel* 250: 245–53.

Zhu, Lijuan, Feng Jin, Minghui Fan, Junxu Liu, Rui Chang, Qifang Jia, Chi Tang, and Quanxin Li. 2018. "Bio-oil as a Potential Biomass-derived Renewable Raw Material for Bio-phenol Production." *Chemical Engineering & Technology* 41 (5): 1027–34.

Zijlstra, Douwe S, Ciaran W Lahive, Coen A Analbers, Monique B Figueirêdo, Zhiwen Wang, Christopher S Lancefield, and Peter J Deuss. 2020. "Mild Organosolv Lignin Extraction with Alcohols: The Importance of Benzylic Alkoxylation." *ACS Sustainable Chemistry & Engineering* 8 (13): 5119–31.

Zuluaga, Carolina Londoño, Jing Du, Hou-Min Chang, Hasan Jameel, and Ronalds Wilfredo Gonzalez. 2018. "Lignin Modifications and Perspectives towards Applications of Phenolic Foams: A Review." *BioResources* 13 (4): 9158–79.

8. Appendixes

The tables and calculations listed in the supplementary information are submitted as excel files and they are as follows:

SI. Table1. Literature on lignin-based phenolic resins

This table summarized 59 case studies. In all these works, lignin from different sources is used as raw material. The main source of lignin is mentioned, and then the selected extraction method to isolate/purify lignin is specified. Moreover, extra information on the characteristics of purified lignin is mentioned like its molecular weight if available. The next step is lignin depolymerization or modification, and each of these routes have several subcategories that are all included. In very limited



numbers of these cases, the lignin is directly used without any pre-treatment, and they are all marked. Lastly, lignins are prepared for various application which are listed in the along with the references.

SI. Table2. *Life Cycle Inventory for the RCF case study.*

This is an excel file with several sheets on each specific part of the process. In each section, the inventory information with the references can be found, and the material and energy balances are further detailed with explanations, and all the formulas used.

SI. Table3. *Life Cycle Inventory of the Bio-oil case.*

This table includes the formulas and all the information used for energy and material balances, and emissions related to each step. (The bio-oil case needs to be updated and further studied, as this report is written before the end of current internship).

SI. Table4. *Results of the LCA modelling.*

This excel file includes are the raw data from Activity Browser for all the case studies, and the graphs and figures produced based on the initial values. Moreover, it includes all the formulas used in the calculation, and it provides more details on how the contribution of main process in each impact category was calculated.